

POLICE COMMITTEE
January 19, 2015
6:00 P.M.
Police Department Training Room
1710 Plainfield Road

1. Call to Order
2. Public Comment and Communications
3. Approval of Meeting Minutes – October 20, 2014
4. Ordinance – Surplus Property
5. Motion to Approve Purchase of Department Owned Glock
6. Motion to Approve Purchase of Crime Scene Barrier
7. Motion to Approve Purchase of Vigilant License Plate Reader
8. Motion to Approve Purchase of TI Simulator Equipment
9. Motion to Approve Purchase of Gas Masks
10. Update on Crime Free Housing
11. Update on Burglary Pattern from November 17th
12. Update on Renovation of Evidence Room
13. Discuss Purchase of Radar Speed Sign
14. Discuss Coffee With a Cop
15. 12th Period Monthly Report
16. Next Meeting Date – February 16, 2015
17. Adjournment

**POLICE COMMITTEE
MEETING MINUTES
October 20, 2014**

Call to Order

The meeting was called to order at 6:00 p.m. in the police department training room. In attendance: Alderman/Chairman McIvor, Alderman Kenny and Alderman Belczak, Chief Brown, Deputy Chief John Cooper, Administrator Vana.

Public Comment and Communications

There were no public comment or communications presented.

Minutes

The minutes of the August 18, 2014, Police Committee meeting were unanimously approved.

Sale of Surplus Property

Staff requested various pieces of city property to be declared as surplus and auctioned using an on-line auction service "Public Surplus" or disposed of. The Committee unanimously recommended approval.

Purchase of Patrol Rifles

The Police Department's current rifles have been in service for at least ten years. There have been some technology upgrades to the AR-15 rifle platform which cannot be accomplished with our current rifles. This includes adding a Red-Dot optical site for quick and accurate sighting on targets and shorter barrel lengths that will make it easier to remove from the squads. The Department will use seized funds to purchase these rifles at a cost of \$32,579.00. The committee unanimously recommended approval.

Purchase of Storage System for Evidence Room

The Staff recommends that the Police Committee approve a proposal from Ellis Systems Corporation in the amount of \$26,436.31 for the purchase and installation of a storage/shelving system in the Police Department's Evidence and Property Room. The Committee unanimously approved.

Purchase of Tracking/Bar Coding System

The Staff recommends that the Police Committee approve a proposal for the "BEAST" Evidence Management/Bar Coding Software System from – Porter Lee Corporation in the amount of \$13,974.50 for the Police Department evidence room. The Committee unanimously approved.

Monthly Report

The review of the written monthly report will be done at the Council meeting. Chief Brown did highlight several items in the report.

Adjournment The Committee Meeting was adjourned at 6:46 p.m.

Approved: _____
Date

Alderman: _____
Joseph Kenny

Chairman: _____
Sylvia McIvor

Alderman: _____
Thomas Belczak

**AGENDA MEMO
Police Committee
January 19, 2015**

ISSUE STATEMENT

Approval of an ordinance authorizing the disposal of surplus property.

BACKGROUND/HISTORY

Staff is requesting that the following property be declared as surplus property and auctioned using an on-line auction service "Public Surplus" or disposed of.

ITEM	EXPLANATION
1 CMI PBTs – SD #2	No longer useful to City
2 Cage from Evidence Room	No longer useful to City
3 2007 Crown Vic VIN #2FAFP71W87X102049	Based on repairs needed, No longer useful to City

STAFF/COMMITTEE RECOMMENDATION

Based upon the above information, staff recommends that the items listed above be declared surplus property and be auctioned or disposed of.

ALTERNATE CONSIDERATION

Not approving this ordinance at this time would be an alternate consideration.

DECISION MODE

If approved by the Committee, this item will be placed on the February 2, 2015 City Council Agenda for formal Council approval.

AGENDA MEMO
Police Committee
January 19, 2015

ISSUE STATEMENT

Staff is requesting to purchase department owned pistols using Department of Justice Award Money.

BACKGROUND/HISTORY

Newly hired officers have been issued Police Department owned Glock pistols since 2007. Prior to 2007 officers were required to purchase their own duty weapon. Some of these officers are carrying Glock pistols that are 25 years old. Only 10 of the current 34 officers are carrying department owned pistols.

Staff is looking to standardize the duty pistol for all department members. The GEN 4 Glock 22, .40 pistols will be the Department issued duty weapon. The GEN 4 pistol offers 3 different back straps to fit any sized hand, improved recoil control and an ambidextrous magazine release. The pistols will be equipped with night sights and a rail-mounted flashlight for working in low light situations.

Standardizing the duty pistol will allow for sharing ammunition in a tactical situation and cut down on purchasing different ammunition for the other caliber (.45) currently being carried.

STAFF/COMMITTEE RECOMMENDATION

Staff is requesting to purchase (38) Glock 22 pistols, holsters, mag pouches and rail mounted flashlights from Ray O'Herron Co., Inc. in the amount of \$25,830.66.

The old Department issued pistols will be traded in to Ray O'Herron Co., Inc.

ALTERNATE CONSIDERATION

The alternate consideration would be to not purchase the Glocks at this time.

DECISION MODE

This item will be placed on the February 2, 2015 agenda for formal Council consideration and approval.

Quotation/Order Form

Ray O'Herron Co.

1600 75th. St.

Downers Grove, IL 60516

630-629-2677

Prepared By: Dan Yara

Sales Representative

Email: dpyara@comcast.net

Office #708-532-5712

Fax #708-532-5714

Order Information;

PO #

Name / Badge #

Date: 01/14/2015

Quotation #1114

Darien Police

Attn: DC John Cooper

Phone#

Fax#

Price effective through: Feb. 28th. 2015

Ray O'Herron is pleased to submit the following proposal:

Terms: Net 30 Days

ITEM#	QTY	DESCRIPTION	PRICE	TOTAL
Glock Quote				
These are all Department owned pricing				
	38	Glock 22 With Trijicon Sights	\$429.00	\$16,302.00
6360-	34	Holster with Light, Plain or B/W Finish	\$145.99	\$4,963.66
75-83-48	34	Mag. Dbl. Open Pouch, STX B/W Finish	\$18.50	\$629.00
775-83-48	34	Mag. Triple Open Pouch, STX B/W Finish	\$20.00	\$680.00
79-83-48	34	Mag. Dbl. Slim Open Pouch. STX B/W Finish	\$22.50	\$765.00
69210	38	Streamlight TLR-1s	\$100.00	\$3,800.00
			TOTAL	\$75,830.66

We look forward to your order



KIESLER'S POLICE SUPPLY, INC.

2802 SABLE MILL RD - JEFFERSONVILLE, IN 47130

EIN # 35-1361847

Orders: (800)444-2950

Information: (812)288-5740

Fax: (812)288-7560

QUOTE

	Sold To L03762	DARIEN POLICE DEPARTMENT 1710 PLAINFIELD ROAD ATTN: CAROL KOPTA 630-971-3999 DARIEN, IL 60561 (630)971-3999	Ship To	DARIEN POLICE DEPARTMENT 1710 PLAINFIELD ROAD DARIEN, IL 60561
DEPT QUOTE				

Our Order #	Date	Rep ID	Order No.	Ord Date	Ship Via	Terms	Inv No.
00747109	01/14/15	IL/JMR	*****	01/14/15	NET 30/DRP SHIP	NET 30 DAYS	

Item/Description		Quantities	Units	Price	Amount
GLOCPG22502**		Ordered 38.0000			
GLOCK 22 GEN4 40S&W PSTL TNFR FXD		Shipped .0000	EACH	357.000	13566.00
TRIJGL01		Ordered 38.0000			
TRIJCON NS GLOCK 9MM/40CAL/357		Shipped .0000	PR	83.000	3154.00
SAFA6360-832-81		Ordered 34.0000			
SAFARILAND ALS LVLIII RET DUTY GLK		Shipped .0000	EACH	138.000	4692.00
17/22 M3 LIGHT					
CCMAK					
SAFA079-83-8		Ordered 34.0000			
SAFARILAND MODEL 079 OPEN TOP		Shipped .0000	EACH	23.000	782.00
DOUBLE MAGAZINE POUCH (SLIMLINE)					
CMKE					
STRE69110		Ordered 38.0000			
STREAMLIGHT TLR-1 WEAPON LIGHT		Shipped .0000	EACH	104.450	3969.10
MEOA					
FORMAT JENNA		Ordered 1.0000			
QUOTED BY JENNA RICHIE		Shipped .0000	EACH	.000	.00
KIESLER POLICE SUPPLY					
2802 SABLE MILL ROAD					
JEFFERSONVILLE, IN 47130					
				TOTAL	\$26,163.10

(continued on next page)

Non-Taxable	Taxable	Sales Tax	Freight	Misc	* Invoice Total *
-------------	---------	-----------	---------	------	-------------------

RETURNED GOODS POLICY

No returned goods will be accepted without prior consent. Any packages returned without properly displaying a return authorization number will be refused. All returned goods will be subject to a restocking fee.

DEFECTIVE MERCHANDISE POLICY

We are not a warranty repair station for any manufacturer. Returns of defective merchandise must be made directly to the manufacturer for repair or replacement.

DAMAGED GOODS POLICY

Claims of shortages or damaged shipments must be made immediately upon receipt of shipment.

AGENDA MEMO

Police Committee

January 19, 2015

ISSUE STATEMENT

Staff is requesting to purchase a portable crime scene barrier from SRN, Inc. using Department of Justice Award Money.

BACKGROUND/HISTORY

In recent years the police department has handled multiple death/crime scene investigations that occurred outside and in the public view. The investigative process generally requires the body of the deceased to remain in place, often for as much as four to five hours while the scene is fully processed. The issue of cross contamination of evidence prevents the body from being covered by blankets or other items. In an effort to ensure that evidence is preserved, as well as the dignity of the deceased and the sensibilities of our citizens are not assailed by often gruesome scenes, we are seeking to purchase one of these pieces of equipment to deploy for crime scenes where these factors are present. Staff has researched and found a portable barrier system that will block these scenes from the public. This system comes in a rolling case that will allow easy transport from the station to the scene.

STAFF/COMMITTEE RECOMMENDATION

The Staff recommends that the Police Committee approve the purchase of the SRN 1000 Premier Double barrier system in the amount of \$5,197.00 using Department of Justice forfeited and awarded funds.

ALTERNATE CONSIDERATION

Not to purchase the barrier at this time.

DECISION MODE

This item will be placed on the February 2, 2015, City Council agenda for formal consideration.



PRIVACY - SAFETY - SECURITY BARRIERS

SRN, Inc.
7323 Westminster Ct.
Bradenton, Florida 34201

(OFFICE) 855-372-7870 (FAX): 941-358-0468

PRODUCT QUOTE

Date	Associate or Reseller ID
1/15/2015	Phil Cannova
Invoice #	
PO #	

Ship To:

Darien Police Department
 1710 Plainfield Rd
 Darien, Illinois
 Attn: Deputy chief Cooper

Bill To:

TBD

Item#	Qty	Description	Unit Price	Total
222000	1	SRN 1000 Premier Double Barrier System	\$4,897.00	\$4,897.00
2880900	20	Stencil Letters (up to 20 letter letters per-top barrier no-charge (additional letters \$1.00 each)		
		Double Barrier System Components		
		6 Tripods		
		10 Privacy Barrier Screens		
		2 Mobile Travel Bags		
		6 Beacons		
		6 Teathers		
		2 Medium Bags (House the Weights and Ballast)		
		BONUS 6 FEET OF COVERAGE (NC)		
		30 Feet (total Coverage Length)		

Sub Total	\$ 4,897.00
Sales Tax	
Shipping	\$300.00
Total	\$ 5,197.00

Pricing is valid 45 days from product quote
 Please make all checks payable to SRN, Inc.



PRIVACY - SAFETY - SECURITY BARRIERS

SRN 1000 Privacy-Safety and Security Barrier System Sole Source and System Specification Sheet

The SRN 1000 BARRIER SYSTEM is a manufactured product that is unique to the industry. SRN, Inc. develops and produces the System in the United States where all additional parts can be ordered if needed, and the System is one of a kind considering capabilities and components. There is not another company that produces anything similar of its kind except SRN, Inc. Attached is a picture of the SRN 1000 System in full extension. The poles are 3 ½ feet that extend to 6 ½ feet, and attached to a tripod. A 15 pound weight is placed on each tripod to increase the stability and wind resistance. When poles are extended, the security screens are then attached to two poles by way of a vertical turret which is permanently attached to each pole. The Vertical Turret has six holes in each of them allowing you to connect systems together making it expandable. The turret also spins which gives you the ability to angle the system according to the scene. Once the screens are in place, bungee cords that are strategically placed around the hem of the screens are secured to the poles. As the wind blows, the bungee cords continually bring the screens back into place and a magnet, sewn into the fabric, reattaches to the steel pole. A battery operated warning light is placed on top of each pole. Assembly and disassembling are accomplished in a few minutes by one individual. The SRN 1000 has been known to withstand winds up to 25 MPH with one 15lb Ballast bag on each of the three tripods. For additional wind coverage doubling up the ballast bag on each tripod has been known to assist. Each system comes with a travel size bag with four wheels. Two wheels that fold out underneath the bag and two wheels on the bottom of the bag. The hard plastic bottom allows the end user to slide the bag easily into a van if necessary. One handle on the bottom of the bag and one handle on the top provide simplicity for lifting. The bag housing the system weighs 55 Lbs. The travel size two wheel bag, which is also included with one system, will house the Ballast Bags along with the three beacon lights and four tethers.

For Company Information and a personal Demonstration: Visit www.srn1000.com

Carl S. Cannova
SRN, Inc.
President
Office (855) 372-7870
Cell (941) 724-2275
carl@SRN1000.com

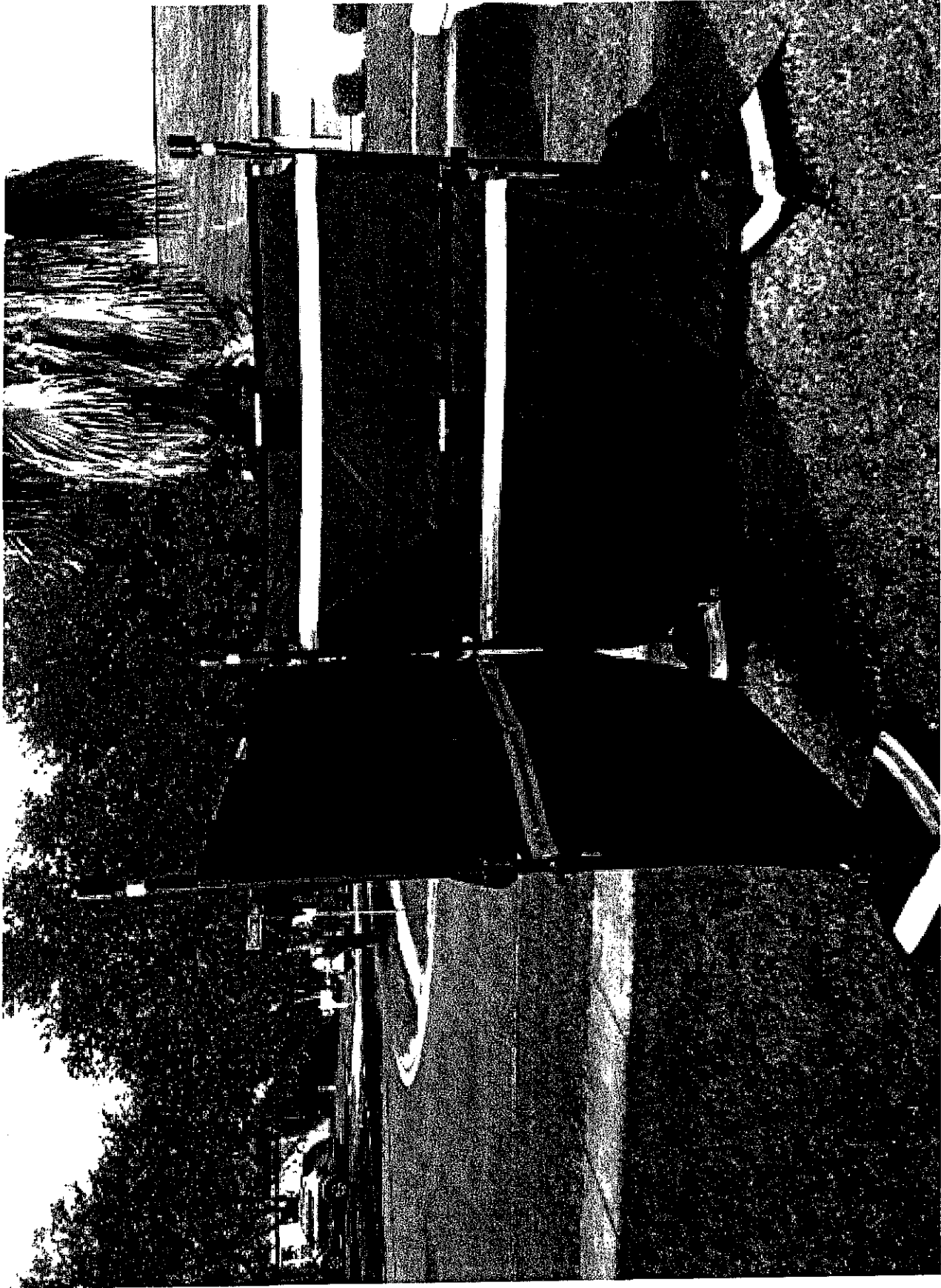

For additional photos visit: <http://srm1000.com/gallery/>

John Cooper

From: phillip Cannova <phillip@srn1000.com>
Sent: Thursday, January 15, 2015 5:41 AM
To: John Cooper
Cc: 'Carl Cannova'
Subject: SRN, Inc. (Privacy-Safety and Security Double Barrier System Quote)
Attachments: Darien Illinois PD Quote 1-15-15.xlsx; Sole Source Letter for SRN 1000 Privacy-Safety and Security Barrier System 2014-2015.docx

Good Morning Deputy Chief Cooper,

Happy new Year and it's great to hear from you again! Attached you will find a quote with a delivered price for the Double Barrier System, product number 222000. I have also included a sole source letter for your review. Feel free to reach out to Carl or myself if you have any questions or concerns and we hope to earn your business!! Hope to see you at the Mid-West Security Police Conference again this year.

Thank you,

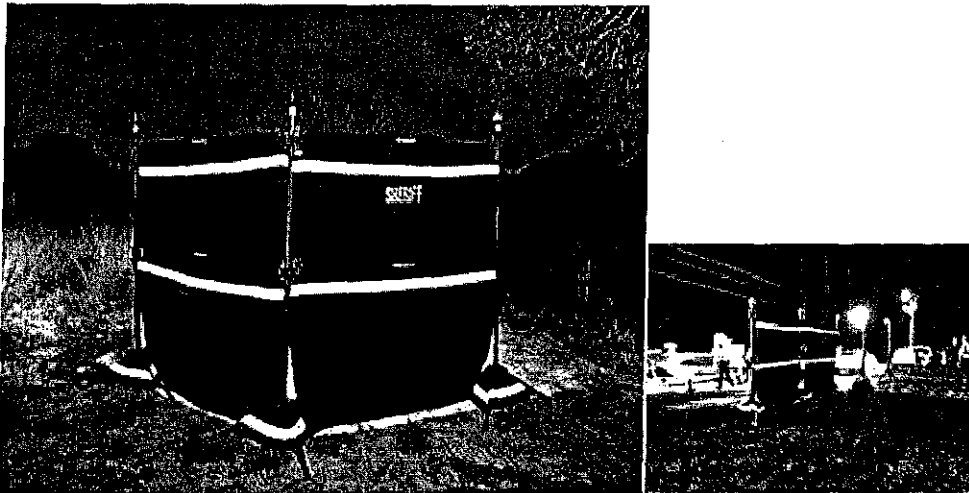

FOR DEMO VIDEO, PRODUCT AND COMPANY INFORMATION VISIT:

<http://srn1000.com/>

September 10, 2014

<http://www.usatoday.com/story/news/nation/2014/09/10/invention-stop-rubbernecking/15376965/>

August 7, 2014 California

<http://www.kesq.com/news/indio-pd-uses-new-barrier-system-to-stop-rubbernecking/27345406>

June 13, 2014 Fox Media Florida

<http://www.myfoxtampabay.com/story/25764635/blocking-the-view-to-keep-traffic-flowing>

Local News DuPont Washington 2013

<http://www.king5.com/news/local/DuPont-public-safety-barriers-238155681.html>

Phillip Cannova

SRN, Inc.

Vice President

(727) 235-1960 Cell

(855) 372-7870 Corp Office

Like us on Facebook

Follow us on Twitter

Find us on LinkedIn

For Video Demo visit

<http://srn1000.com/>

MADE IN THE USA



PRIVACY - SAFETY - SECURITY BARRIERS

"Woman Owned Small Business"

Sarasota, FL

AGENDA MEMO
Police Committee
January 19, 2015

ISSUE STATEMENT

Staff is requesting to purchase (2) License Plate Reader 3 Camera Systems from Vigilant Solutions.

BACKGROUND/HISTORY

License plate reader systems for law enforcement operate as a data gathering resource. There is an intergovernmental agreement between the police department and NCIC and the local DMV or Secretary of State. The agreement allows for daily downloads of data on wanted vehicles and wanted persons driving certain vehicles. When the LPR is activated and captures data on a vehicle in the data base, it alerts the user and the user initiates an investigation based upon the hit. The Vigilant system will also alert the other officers on the Darien Police Department via an alert through the MDC.

The purchase of the VIGILANT License Plate Reader System as opposed to the other machines is predicated more on its available subscription services than its initial price offering. The subscription service is substantially lower than its competitors, and places it far above the various competing companies and its ancillary services are not offered by competitors.

Vigilant offers for sale its systems to private corporate entities that collect license plate data. This data is then made available to all of Vigilant's law enforcement customers and then allows those agencies to use the data and analyze it in an effort to solve crimes. That level of data collection in specific geographic areas allows for the crime fighting and crime prevention that will bode well for Darien in the future and for our crime analysis as well.

STAFF/COMMITTEE RECOMMENDATION

The Staff recommends that the Police Committee approve the purchase of the additional equipment in the amount of \$35,940.00 from Vigilant Solutions using DOJ award money.

ALTERNATE CONSIDERATION

Not to purchase the additional equipment at this time.

DECISION MODE

This item will be placed on the February 2, 2015, City Council agenda for formal consideration.



500 45th Ave.
Munster, IN 46321
219-924-1765 (Office)
219-924-1768 (Fax)

January 13, 2015

Chief Brown and Chief Cooper,

Attached please find quotations for the Vigilant Solutions Intelligence Led Policing (ILP) packages as requested.

To recap, the Intelligence Led Policing package consists of 3 parts:

- LPR Hardware
- Private LPR Data Access via LEARN
- Face Search Facial Recognition Software

The first quote attached will provide the City of Darien with the following:

- (2) – 2 Camera mobile LPR units; unlimited user access to LEARN Private LPR Data, and unlimited user access to Face Search with up to 10,000 local booking images uploaded. This subscription period will include all access for 2 years

The second quote contains all of the above, but adds an additional LPR camera to the mobile LPR kits, thus making them (3) camera mobile LPR kits.

Additionally attached is the standard Enterprise Service Agreement, which should be executed and submitted upon order.

Lastly, as discussed, the ILP package is a renewable subscription program. At the end of the second year, should the Darien Police Department wish to renew the package, all of the previously described software access shall continue, and in addition to the hardware already owned, an additional 2-camera mobile LPR unit OR 2 Fixed LPR cameras will be included in the renewal cost.

The ILP package renewal cost is included in the Enterprise Service Agreement. Based upon the Agency size of Darien, this would be \$10,630 (not including installation and setup services).

Thank you again for the opportunity to offer this program to the City of Darien Police Department.

Best regards,

Randy Swets, Solution Specialist and Vigilant MR
Miner Electronics

		Vigilant Solutions 2021 Las Positas Court Suite # 101 Livermore, CA 94551 (P) 845-797-3092 (F) 925-398-2113		Protecting Officers, Families and Communities	
Attention:	Chief Brown	Date:	1/12/2015		
Project Name:	Darien IL Police	Quote Number:	KJS-0385-01		

PROJECT QUOTATION

We at Vigilant Solutions are pleased to quote the following systems for the above referenced project:

Qty	Model #	Description
(2)	VS-ILP-1M-RE	Vigilant Intelligence Led Policing Package w/ Mobile LPR Hardware (Reaper) - Up to 100 Sworn <u>Hardware Includes:</u> <ul style="list-style-type: none"> • 2-Camera Mobile LPR system - Quantity = 1 LPR System (Reaper Cameras) <ul style="list-style-type: none"> o Power over Ethernet (POE) LPR cameras w/ Integrated processors o Lens configuration to be confirmed by customer at time of order <u>Software / Services Include:</u> <ul style="list-style-type: none"> • CarDetector Mobile LPR Software for MDC Unit <ul style="list-style-type: none"> o Includes Mobile Hit Hunter Data Access Feature • LEARN Software as a Service (SaaS) including: <ul style="list-style-type: none"> o LEARN Data Analytic Tools o Unlimited Private LPR data Access o Hosting, data and system management of LPR data o LEARN-Mobile Companion SmartPhone application (Android & iPhone) • First year Standard Service Package for hosted LPR server access • FaceSearch Hosted Facial Recognition <ul style="list-style-type: none"> o Image gallery of up to 5,000 images
(1)	SSUPLN-COM	Vigilant Start Up & Configuration of Hosted/Managed LEARN Server Account <ul style="list-style-type: none"> • New client account setup via national LPR server • Required for all hosted/managed LEARN client accounts
(2)	SSUPSYS-COM	Vigilant System Start Up & Commissioning of 'In Field' LPR system <ul style="list-style-type: none"> • Vigilant technician to visit customer site • Includes system start up, configuration and commissioning of LPR system • Applies to mobile (1 System) and fixed (1 Camera) LPR systems
(1)	VSPTRNG	Vigilant End User Training for LPR Systems <ul style="list-style-type: none"> • End user training for Vigilant products <ul style="list-style-type: none"> o Covers all client purchased applications o Includes classroom and field operation training • Vigilant certified technician to visit site and perform one training class
(1)	VSPTRVL-01	Vigilant Certified Partner Travel via Client Site Visit <ul style="list-style-type: none"> • Vigilant certified technician to visit client site • Includes all travel costs for onsite support services
(2)	VS-LBB-FS-VBAR-02-A	LPR Camera Mounting Brackets - For Federal Signal Valor light bar - Complete Set <ul style="list-style-type: none"> • LPR Camera Mounting Bracket - Rooftop under light bar • Compatible with Federal Signal Valor light bar • Mounts up to four (4) LPR cameras
(2)	VS-ILP-Upgrade	ILP Upgrade to 3 Camera Mobile LPR Kit <ul style="list-style-type: none"> • Additional Reaper Camera for Mobile LPR Kits
(1)	VS-SVC-PKG	Basic and Standard Service Package for 3 Camera Mobile LPR <ul style="list-style-type: none"> • Applies to second year licensing

Quote Notes:

1. All prices are quoted in USD and will remain firm and in effect for 60 days.

Quoted by: Kevin Schneider
kevin.schneider@vigilantsolutions.com

Phone: 845-797-3092

email:

Total Price (Excluding sales tax)	\$35,940.00	
Accepted By:	Date:	P.O#



Intelligence-Led Policing (ILP)

Stretched Budgets and Decreased Grants have limited agencies from deploying technology as broadly as they would like. Now, Vigilant Solutions introduces a way for agencies of all sizes to easily deploy and afford a comprehensive suite of technology solutions that may otherwise be unattainable. License plate recognition (LPR) system(s), unlimited use of LPR data from Vigilant's national network of over 2.5 billion detections, a turnkey facial recognition solution, hosted LEARN LPR analytic software, and a new mobile application for agency-wide deployment - this is all available to you today. **Vigilant introduces its Intelligence-Led Policing Package.**

<h2>LEARN[®] Analytic Software</h2>	<p>LEARN includes an agency-wide license to LEARN from the national network of over 2.5 billion detections. This means you can make use of the LPR data you have available.</p>	
<h2>LPR Data</h2>	<p>LEARN includes unlimited use of unlimited hosted LPR database (over 2.5 billion detections) from around the country accessible via LEARN.</p>	
<h2>LPR System(s)</h2>	<p>Every agency needs LPR to improve operations. Every LPR package contains a detailed list of mobile or fixed LPRs to be made of your agency and community.</p>	
<h2>FaceSearch[®] Facial Recognition</h2>	<p>Accessible from any web browser or your Mobile Companion app, FaceSearch contains a turnkey solution that generates leads by searching against your approved data set with Vigilant's own available data.</p>	
<h2>Mobile Companion[®]</h2>	<p>Access Mobile Companion app from your phone, tablet, or laptop from any location. Scan license plates, and use FaceSearch - all from the palm of your hand!</p>	

Enabling Early Identification and Early Apprehension

Everyone in law enforcement ultimately wants to reduce and deter crime. Intelligence-Led Policing provides you with tools to do this by generating additional investigative leads that allow you to prevent future crimes from occurring through early apprehension. ILP also improves officer safety through enhanced situational awareness. Protect your community and your officers with ILP - **Contact us Today.**



ILP Package Benefits:

- ✓ Leverage technology that will improve efficiencies across your entire Agency
- ✓ Improve officer safety with enhanced situational awareness
- ✓ Save over 75% (on average) compared to deploying these technologies individually
- ✓ Reduce crime and save lives

Intelligence-Led Policing

Save over 75% on average compared to deploying individual technologies



Be Vigilant.

*Contact us today to discuss
Intelligence-Led Policing for your Agency.*

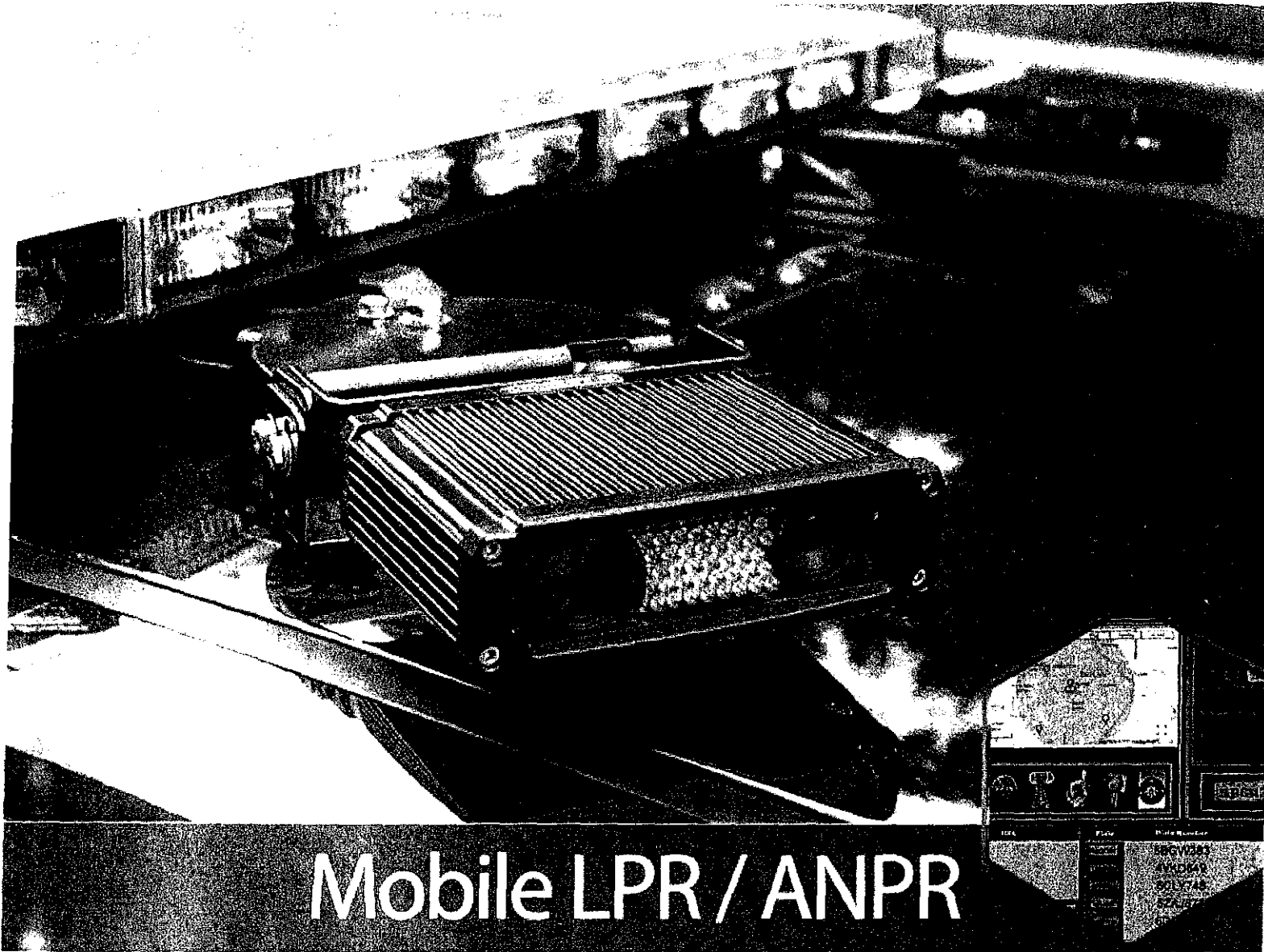

Mobile LPR / ANPR

Mobile LPR at it's Best

Managed from within LEARN, Vigilant's Mobile LPR uses up to four (4) dual-lens LPR cameras, each with integrated Digital Signature Processors (DSP), and advanced imaging and recognition algorithms to provide the most advanced mobile LPR system available. With a simple user interface, the Vigilant Mobile LPR system provides a great deal of functionality with the user's needs in mind, but with advanced capabilities not available elsewhere.

Key Features

- Easy & intuitive interface
- Works with existing laptop or MDT
- No external processor in trunk
- Seamless communication to/from LEARN
- Infrared (IR) plate and color vehicle images
- Mobile Hit Hunter™ exclusive feature provides additional hits from Vigilant's own LPR data network
- Day / Night interface for officer safety
- Large buttons designed for touch screen



Protecting Officers,
Families and Communities

Mobile LPR / ANPR



Mobile LPR from Vigilant is an advanced mobile LPR solution designed from the officer's perspective. Large buttons, visual system status indicators, scrolling plate history, and even a Day / Night mode to eliminate brightness in the vehicle during nighttime operations for officer safety - Mobile LPR from Vigilant is quite simply the most user-friendly interface available on the market.

Mobile Hit Hunter is an exclusive Vigilant feature in that significantly increases the likelihood of "hits". Leveraging all available LPR in your area, including data shared by other agencies as well as Vigilant's national data sharing initiative (NLS) that collects almost 100 million LPR records per month from commercial operations of LPR, Mobile Hit Hunter matches these records against your hotlist(s) and notifies officers within a 3-mile radius of suspect vehicles.

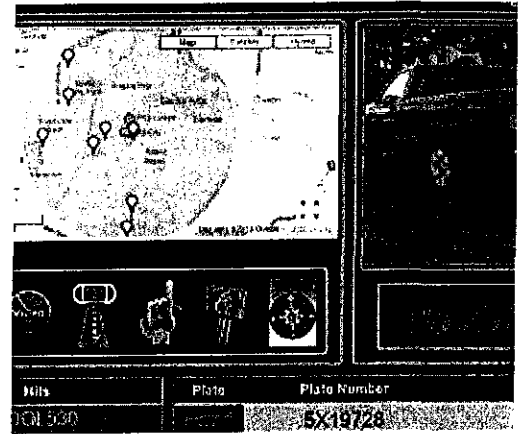

System Components & Key Specifications

All-in-One Integrated LPR
Camera & Processing Unit

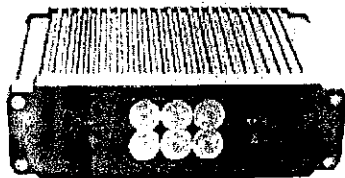

- Dimensions (WxDxH) :
6.9" x 6.5" x 2"
175 x 165 x 51 mm
- No Processor in Trunk
- Weight: 3.5 lbs. / 1.6 kg
- IP67 / NEMA-4 Rated

Compact Camera with
External Processor also Available

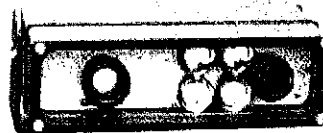

- Camera Dimensions:
6.7 x 3 x 2 in
171 x 76 x 51 mm
- Weight: 1.9 lbs / 0.86 kg
- IP66 Rated

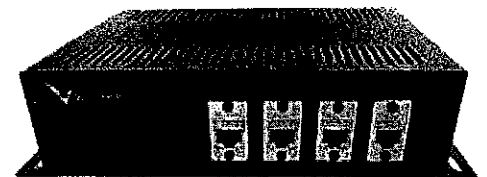

- Processor Dimensions:
5 x 8.5 x 2.5 in
127 x 215.9 x 63.5 mm



LPR Data

Delivering Results

More data means more leads, more closed cases, and more lives saved. Creating the National Vehicle Location Service™ (NVLS) as a data sharing initiative for the United States, Vigilant manages over 2 billion LPR detections. With LEARN, Vigilant enables free agency-to-agency sharing as well as free access to LPR data contributed by an agency to the LS program. This data is making a difference in delivering results every day.

Key Features

- ✓ Management of agency-contributed data per agency-defined data retention policy
- ✓ Point-and-click sharing among LEARN accounts as an alternative to NVLS sharing
- ✓ Commercial LPR data available as a service: ~100 million detections added monthly
- ✓ All data available via LEARN® for advanced queries and analytics
- ✓ Access limited to law enforcement
- ✓ Secure and redundant data center



Protecting Officers,
Families and Communities

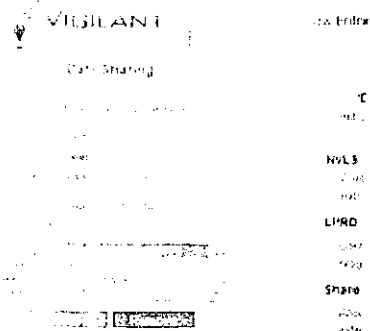

Point-and-click data sharing is made simple within LEARN. Agencies may elect to share their data with the NVLS program to provide access to over 3,000 other agencies and 30,000 sworn law enforcement users, or agencies may select to share only to specific agencies. As always, Vigilant promotes sharing among law enforcement and makes all law enforcement contributed data available at no cost.

Like LPR data is an optional service from Vigilant that significantly increases the available data for agencies in almost every metro area. The data is provided by a third party, DRN, serves the public and commercial sector. DRN has an agreement with its customers allowing them to provide a portion of their LPR data into Vigilant's law enforcement data center. This data is collected from asset recovery specialists, access control and parking systems and other commercial applications. If your systems have not been updated, you are looking for, with almost 100 million new detections monthly, then there is a good chance someone else has.

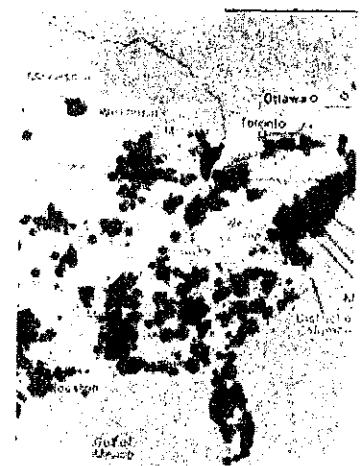

Vendor **Interoperability** is assured with Vigilant. Agencies using any vendor may contact Vigilant to discuss different models for sharing data with the NVLS initiative and take advantage of improved investigative leads resulting from the larger data set.



Open access to law enforcement is a basic premise in Vigilant's LPR data sharing philosophy. Leveraging the cloud to deliver a web-based solution, LPR data from Vigilant (shared by law enforcement or Vigilant's own LPR data) is always available...without the need for additional software, servers, or IT expertise. Basic access is provided to all credentialed law enforcement for simple queries against law enforcement data.

Most of the collected LPR data and controlled access by law enforcement only are at the discretion of the agency. **Contact Vigilant for a white paper on this topic.**



FaceSearch™

Facial Recognition

FaceSearch is an easy-to-use facial recognition solution that works. Available via the web, on mobile devices, and as a PC-based application. FaceSearch was developed by Vigilant to deliver a functional, scalable and affordable solution like no other. Hosted in the cloud, FaceSearch offers easy importing and integration capabilities, along with pre-populated face image data from Vigilant.

Key Features

- ✓ >350 facial vectors exclusively from Vigilant
- ✓ Cloud hosting, local storage, or hybrid Web interface for anytime, anywhere access
- ✓ PC-based enrollment application
- ✓ Pre-populated content from Vigilant including image data from registered sex offender and CrimeStopper websites
- ✓ Easy uploading / integration of local image data from jail management systems and other sources



Protecting Officers,
Families and Communities

FaceSearch



Over 350 facial vectoring algorithms are at the heart of Vigilant Solutions' FaceSearch. Rather than making use of commercially available facial recognition engines, Vigilant leveraged its experience in image recognition to develop these new facial vectoring algorithms in-house. Why? - to benefit you in terms of accuracy, speed, and flexibility in deployment.

Available on **multiple platforms**, FaceSearch offers flexibility for a wide range of applications. The web interface provides accessibility anytime, anywhere, for use by investigators and detectives on any web browser and officers in the field on virtually any mobile device. A PC application for image enrollment is perfect for pre-arrest intake or released supervision for parole, probation, or sex offenders.



A simple interface with lots of image data is a recipe for success. FaceSearch's intuitive interface is enabled by millions of pre-populated face images from Vigilant via registered sex offender, CrimeStopper and other websites. The ease of uploading local data and/or integrating to another system makes FaceSearch a useful tool for any agency.

Stored **in the cloud**. Leveraging Vigilant's expertise in law enforcement management for law enforcement, FaceSearch eliminates the need to invest in and maintain server hardware and the involvement of IT staff. FaceSearch can also be deployed locally at the agency, or in a hybrid solution where the data to reside with the agency, while the search and facial vectors are managed by Vigilant.

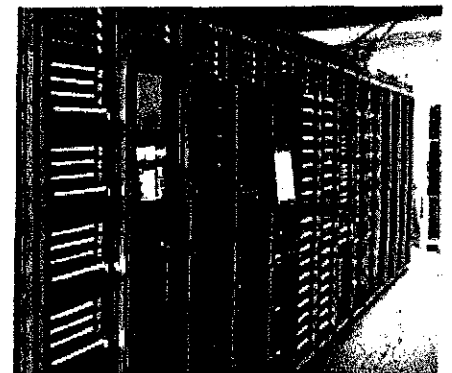

Location Search Summary

Location	Address	Date Range
Loc: # 1	2221 Dunmore Drive, Darien, IL 60561, USA	All Time
Loc: # 2	2300-2320 Oakmont Way, Darien, IL 60561, USA	All Time
Loc: # 3	1504 Old Oak Place, Darien, IL 60561, USA	All Time
Loc: # 4	1395 Chapman Drive, Darien, IL 60561, USA	All Time

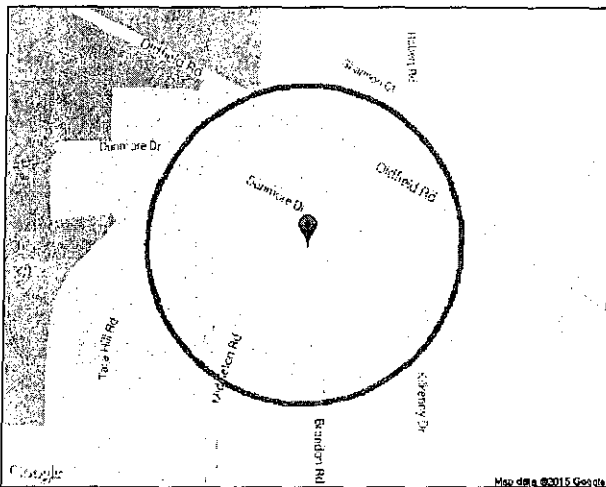

Loc: # 1

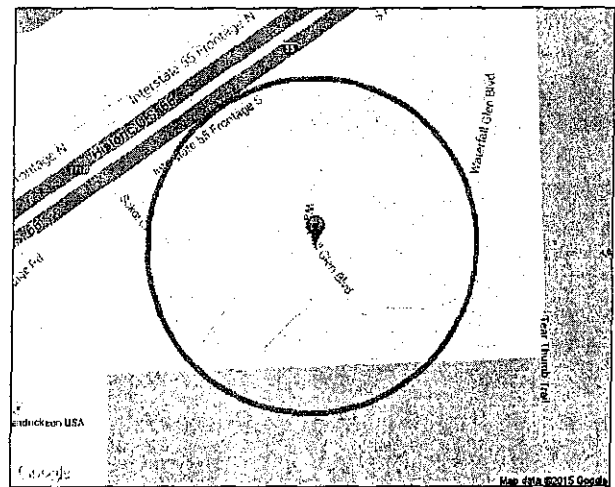

Loc: # 2

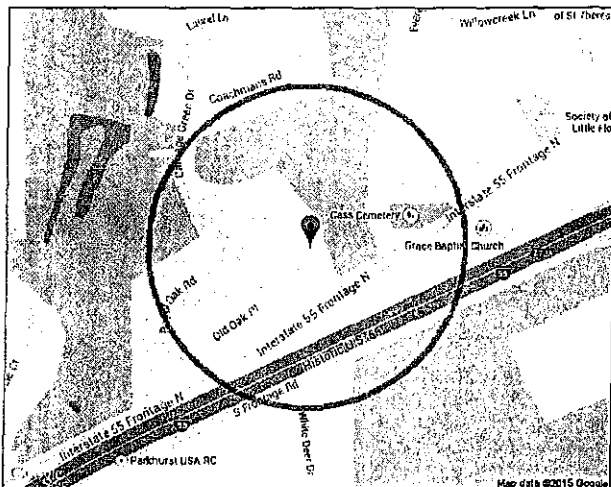

Loc: # 3

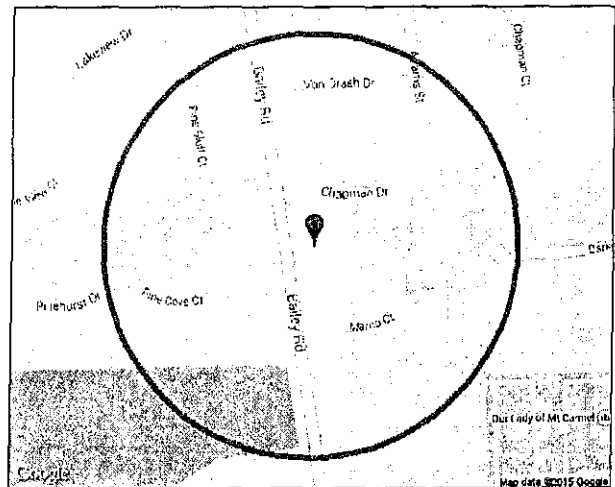

Loc: # 4

Date of Report: 01/13/2015

Location Search Summary

Location	Address	Date Range
Loc: # 5	1511 pinehurst darien il	All Time
Loc: # 6	8805 Lake Ridge Drive, Darien, IL 60561, USA	All Time
Loc: # 7	7309 Brookbank Road, Darien, IL 60561, USA	All Time
Loc: # 8	8538 Thistlewood Court, Darien, IL 60561, USA	All Time

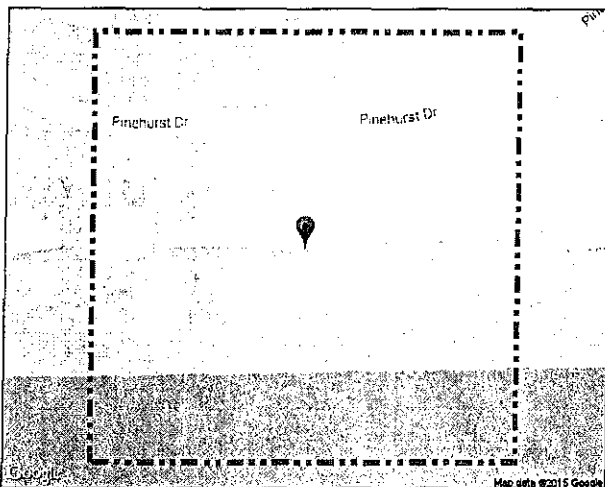

Loc: # 5

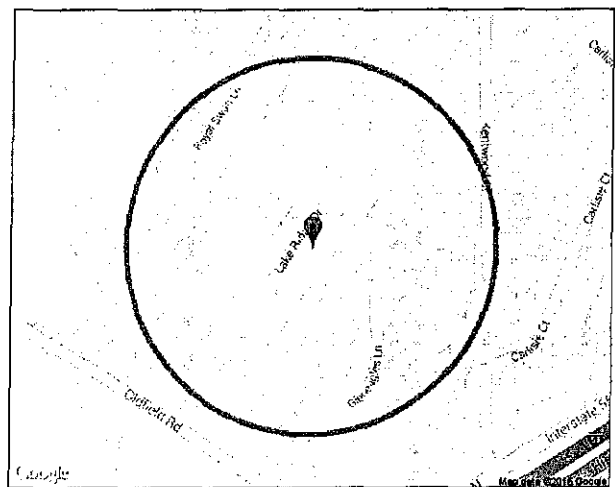

Loc: # 6

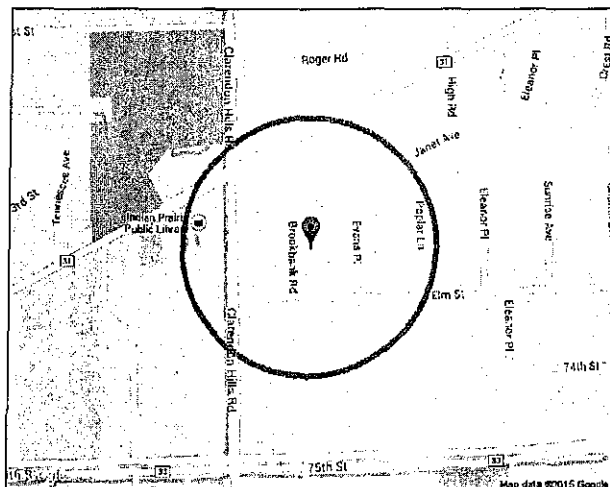

Loc: # 7

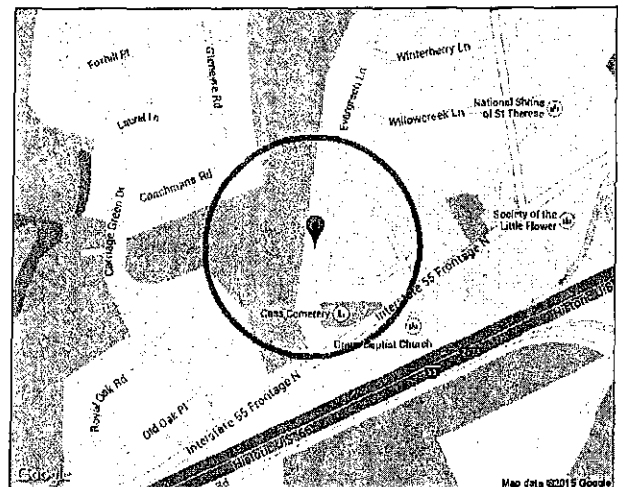

Loc: # 8

Date of Report: 01/13/2015

Location Search Summary

Location	Address	Date Range
Loc: # 9	7310 Sunrise Avenue, Darien, IL 60561, USA	All Time
Loc: # 10	7319 Darien Lane, Darien, IL 60561, USA	All Time

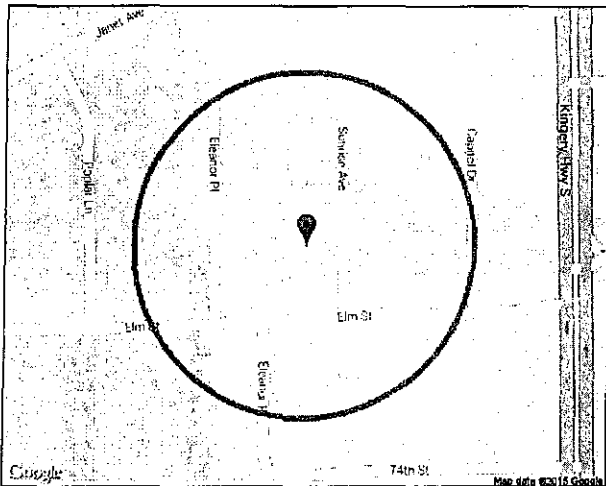

Loc: # 9

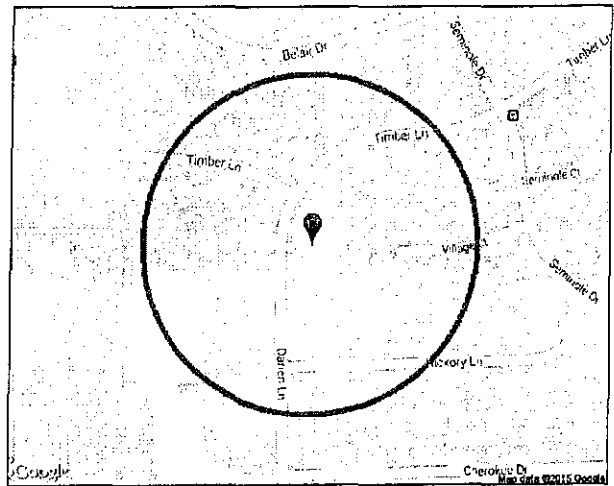

Loc: # 10

Vehicle Summary

Vehicle No.	License Plate	No. of Locations Appeared	Location (Frequency)
1		2	Loc: # 4 (1), Loc: # 7 (1)
2		2	Loc: # 3 (1), Loc: # 7 (1)
3		2	Loc: # 3 (1), Loc: # 8 (1)
4		2	Loc: # 3 (1), Loc: # 8 (1)
5		2	Loc: # 3 (1), Loc: # 8 (1)
6		2	Loc: # 3 (1), Loc: # 8 (1)
7		2	Loc: # 3 (1), Loc: # 8 (1)
8		2	Loc: # 3 (1), Loc: # 8 (1)
9		2	Loc: # 3 (1), Loc: # 8 (1)

2,570 Plates Analyzed to Produce These Results

COMPARISON PURCHASE PROPOSAL FOR EQUIPMENT

AUTOMATED LICENSE PLATE READER SYSTEMS

3M	CDS Technologies	VIGILANT
2- 4 camera mounting systems BOSS Admin system BOSS installation and Training BOSS Mapping using MS Live Mob Port Installation System Mobile 4 cam p634 Mobil ALPR Software group training 3 hour session SUV rear facing light bar mount Travel Fee billing	Main LPR Unit-Sharp X Main Processing Unit USB GPS Unit Auto Vu Sharp X Camera Auto Vu Sharp X camera Auto Vu Sharp X Camera Mobile Mounting bracket 7m Camera Cable Software bundle Software Maintenance Installation and Training	Vigilant Intelligence led policing Package 2 camera mobile system Software service, Car detector LEARN Data Analytic Tool Vigilant Start-up configuration Vigilant End User Training Vigilant Certified Partner LPR mounting brackets ILP upgrade LPR kit Basic and Standard Service Package for 3 camera mobile LPR
\$36,610.00 (2) vehicle set-up	\$26,445.00- (1) vehicle set-up	\$35,940.00 (2) Vehicle set up



3M Center, Bldg 225-4N-14
St. Paul, MN 55144-1000
P: 1-877-777-3571
F: 1-800-591-9293
E: MVSSALPR@3M.com

Quote Number 00001854 Created Date 12/3/2014
Quote Name ALPR 1 Date Expires 3/23/2015

Prepared By Larry Pope
Phone 630-520-0191
E-mail lapope@mmm.com
Fax 865-392-5599

Bill To Name Darien Police Department Ship To Name Darien Police Department
Bill To 1710 Plainfield Rd Ship To
Darien, 60561 United States
United States

Headquartered in St. Paul, MN with a customer contact center in Austin, Texas and a manufacturing facility in Knoxville, TN

Providing products and services designed specifically for Law Enforcement, Security, Access Control, Parking, Tolling, and Intelligent Transportation markets.

3M Public Safety designs, manufactures, installs and supports every aspect of our ALPR products including cameras, processors, software and OCR engines.

Payment term: Net 30 days and are subject to 3M Statement of Terms, Conditions, and Warranties of Sales

Restocking Fee: Returns not due to 3M error are assessed at 15% restocking and handling charge with a minimum charge of \$100.00 plus all transportation charges. (Line items including training, travel fees, installation, and maintenance are exempt from the restocking fee)



3M Center, Bldg 225-4N-14
 St. Paul, MN 55144-1000
 P: 1-877-777-3571
 F: 1-800-591-9293
 E: MVSSALPR@3M.com

QUOTE IS FOR (2) - (4) CAMERA SYSTEMS

Quantity	Product Code	Product	Product Description	Sales Price	Discount	Total Amount	Shipping & Handling
2.00	75-0302-1828-5	4 CAM VALOR MOUNTING ASSEMBLY	Mounting assembly for 4 Cameras on Federal Signal Valor Lightbar	USD 1,250.00		USD 2,500.00	USD 0.00
1.00	75-0302-3113-0	BOSS ADMIN PLUS 2 CONCURRENT USERS	Core license providing administrator access and TWO concurrent users	USD 995.00		USD 995.00	USD 0.00
1.00	75-0302-3696-4	BOSS Install/Admin Training each BO	3M professional installation and administrative training of 3M Back Office System Software.	USD 300.00		USD 300.00	USD 0.00
1.00	75-0302-1924-2	BOSS MAPPING USING MS LIVE EARTH		USD 795.00		USD 795.00	USD 0.00
2.00	75-0302-3694-9	Mob/Port Installation Service per car BO	3M professional installation of a Mobile/Portable ALPR System (per vehicle)	USD 1,200.00		USD 2,400.00	USD 0.00
2.00	75-0302-2029-9	Mobile 4-CAMP634-810-25-25-16-08 VP	Mobile ALPR System with (4) P634 cameras, (1) processor, in-Car software (LPCS), GPS, and cables	USD 17,700.00	20.00%	USD 28,320.00	USD 190.00
1.00	75-0302-3697-2	Software Group Training 3HR Session BO	3M professionally led, 3 hour training session for LPCS or BOSS software for up to 25 people	USD 300.00		USD 300.00	USD 0.00
2.00	75-0302-3564-4	SUV REAR FACING LIGHTBAR MOUNT	Can be added to a mounting system to mount one camera at a steeper angle facing to the rear.	USD 150.00		USD 300.00	USD 10.00
1.00	75-0302-3693-1	Travel Fee- Zone Two Billing Only		USD 500.00		USD 500.00	USD 0.00
Quote Total				USD 36,410.00			
Shipping and Handling				USD 200.00			
Quote Grand Total				USD 36,610.00			

Notes:

Headquartered in St. Paul, MN with a customer contact center in Austin, Texas and a manufacturing facility in Knoxville, TN

Providing products and services designed specifically for Law Enforcement, Security, Access Control, Parking, Tolling, and Intelligent Transportation markets.

3M Public Safety designs, manufactures, installs and supports every aspect of our ALPR products including cameras, processors, software and OCR engines.

Payment term: Net 30 days and are subject to 3M Statement of Terms, Conditions, and Warranties of Sales

Restocking Fee: Returns not due to 3M error are assessed at 15% restocking and handling charge with a minimum charge of \$100.00 plus all transportation charges. (Line items including training, travel fees, installation, and maintenance are exempt from the restocking fee)



3M Center, Bldg 225-4N-14
St. Paul, MN 55144-1000
P: 1-877-777-3571
F: 1-800-591-9293
E: MVSSALPR@3M.com

- (2) -4 camera Mobile units with rear facing.
- includes Hardware. Software. Installation and Training by 3M personnel.
- (1) yr Warranty

Headquartered in St. Paul, MN with a customer contact center in Austin, Texas and a manufacturing facility in Knoxville, TN

Providing products and services designed specifically for Law Enforcement, Security, Access Control, Parking, Tolling, and Intelligent Transportation markets.

3M Public Safety designs, manufactures, installs and supports every aspect of our ALPR products including cameras, processors, software and OCR engines.

Payment term: Net 30 days and are subject to 3M Statement of Terms, Conditions, and Warranties of Sales

Restocking Fee: Returns not due to 3M error are assessed at 15% restocking and handling charge with a minimum charge of \$100.00 plus all transportation charges. (Line items including training, travel fees, installation, and maintenance are exempt from the restocking fee)

John Cooper

From: Larry Pope <lapope@mmm.com>
Sent: Wednesday, December 3, 2014 1:22 PM
To: John Cooper
Subject: Mobile ALPR quote
Attachments: ALPR 1_V1.pdf

DC Cooper,

Please see the attached quote for 2-4 camera mobile ALPR units.

3M is the only US company which designs, manufactures, services, and supports our own ALPR equipment . We do not resell other manufacturer's solutions who combine cameras, processors, and software from multiple vendors.

We have a large footprint both in Illinois and the upper Midwest of Law Enforcement agencies , and are supported by a multi-billion dollar corporation. 3M provides the license plates, or the manufacturing technology for 49 out of 50 States, which reinforces the strong design integration and accuracy required for ALPR technology. No other vendor is in this position.

Should you have any questions, please feel free to contact me if you have any questions.

regards,
larry

Lawrence A. Pope | Public Safety
Traffic Safety and Security Division
St. Paul, MN, 3M Center, Bldg. 235-3A-09 | St. Paul, MN 55144-1000
Office: 630 520 0191 | Mobile: 312 972 3170 | Fax: 651 732 8782 lapope@mmm.com | www.3M.com/mvss

Need additional support? Call our dedicated support line at 877-777-3571, or email: alprsupportus@mmm.com

3M Traffic Safety and Security Division



Ingenious Solutions for a Secure World

Automatic License Plate Recognition Technology
for the safety of our communities

3M

GLOBAL INDUSTRY LEADING TECHNOLOGY

Designed and manufactured in house for over 20 years, 3M Traffic Safety and Security Division boasts an expansive automatic license plate recognition product line filled with industry leading technology. Our hardware reliability and software accuracy coupled with dependable service has led to the deployment of 3M™ ALPR systems in over 50 countries.

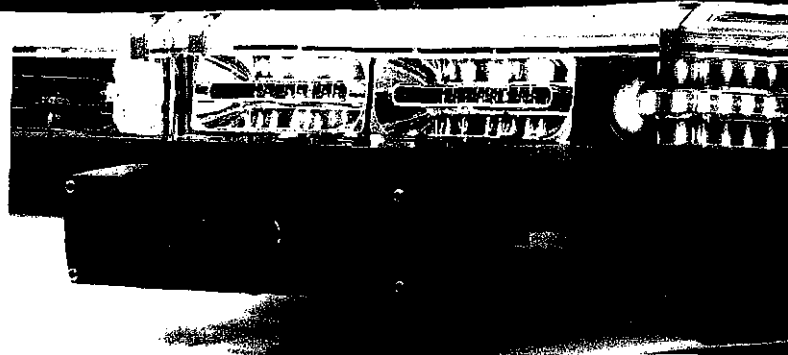

FULL SPECTRUM OF SOLUTIONS Trusted Technology from 3M

Our complete line of ALPR hardware and software has been deployed in many applications around the world, helping customers increase productivity, stop criminal activity, and even collect data for traffic analysis. Whatever your goal, 3M has the solution you've been looking for:

- **CAMERAS**—Available for fixed or mobile deployments, 3M cameras feature unique technologies to enhance read accuracy by suppressing ambient light such as headlights and bright sunlight.
- **HARDWARE**—Engineered and tested specifically for use with 3M ALPR systems, our rugged processors and accessory components provide unmatched durability.
- **SOFTWARE**—An array of software packages add analytical functionality and reporting capability to a wide variety of applications including law enforcement, tolling, congestion charging, access control, and parking.
- **SERVICES**—Offering on-site installation, training, consultation, and much more, 3M is committed to the success of your deployment.

The Long Beach Police Department's ALPR system has been a huge asset to the department and has been one of the primary systems utilized by both patrol officers and detectives to solve crime.

On the patrol side, our ALPR system has read over 50M plates, led to over 500 arrests, assisted in the recovery of over 2500 stolen vehicles and led to the impoundment of over 7000 parking scofflaws' vehicles. Over \$3.4M in outstanding parking revenue is attached to those vehicles!

On the investigation side, the 3M ALPR system has been and continues to be, an invaluable technology for our detectives. From identifying and locating hit and run vehicles to placing homicide suspects at the scene of the crime, it can all be done with ALPR. Our department is using the investigative side of the technology as much, or even more than the patrol side.

— Lieutenant Christopher Morgan, Long Beach Police Department



3M ALPR

THE FORCE MULTIPLIER
INCREASING OFFICER
PRODUCTIVITY AND
SAFETY WITH EVERY
DEPLOYMENT

1 Photo Data



4 Officer Receives Alerts

3M Mobile ALPR Processor

- Designed specifically for the vehicle environment
- Powerful processing and storage for databases of interest and collected reads between shifts



Databases of Interest
NCIC, DMV, DOJ and Local Regional

2 Reads and Hits

3 Database Information

3M™ MOBILE ALPR SYSTEMS

Proactive, Preventative Enforcement

3M Mobile ALPR Systems assist on-street patrol officers checking for criminal activity by capturing and analyzing license plates against known databases. This compact, rugged system has been IP67 certified and mounts securely below the lightbar for limited visual interference.

Features and Benefits

- Offers high resolution coverage for a full lane of traffic with up to two concurrent vehicles in the field of view.
- Instantly checks captured plates against one or more databases of interest to immediately alert officers of hits.
- Increases spatial awareness for improved officer safety.
- Enhances proactive, preventative enforcement by enabling more intelligent investigations and data sharing across jurisdictions.
- 3M™ Back Office System Software stores all collected data in a central location to support data analysis, data queries and reporting for law enforcement investigations (in accordance with each jurisdiction's data retention policy).

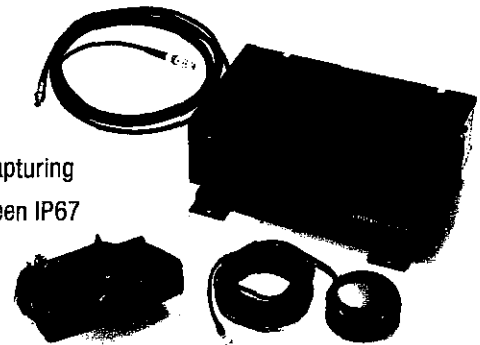

Applications

Public safety for high crime areas with large volumes of local traffic

On-street enforcement of:

- Stolen Vehicles
- Amber Alerts
- Unregistered Vehicles
- Wanted Criminals
- Parking Violations
- Bolos

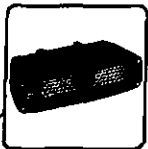

3M Mobile ALPR Camera
Superior plate capture performance bundled in a compact, low profile design



3M License Plate Capture Software
The user-friendly and intuitive interface providing alerts and search functionality to every patrol officer

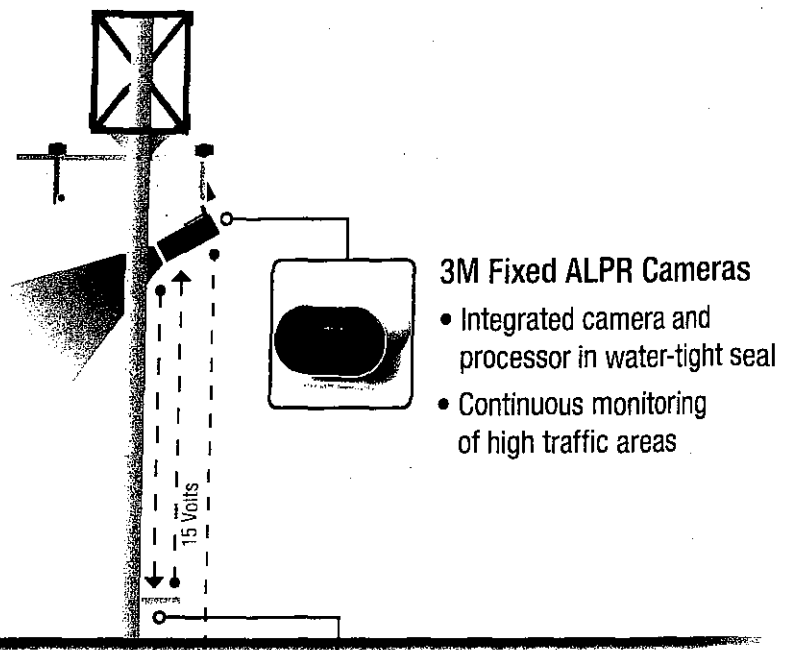

- 3M Fixed ALPR Cameras**
- Integrated camera and processor in water-tight seal
 - Continuous monitoring of high traffic areas

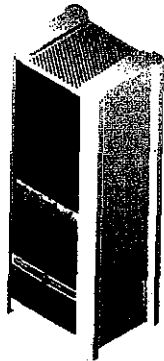
1a Communications via Terminal Box (Wireless, Ethernet, Lan)

1b Communications via Camera (Wireless, Ethernet, Lan)

3M Back Office System Software
The central repository to all license plate data along with tools to support data analysis, queries and reporting



3M Termination Box

- Providing easy access to all hardware interfaces and power supply to deployed Fixed ALPR Camera
- Enclosed in NEMA weatherproof enclosure

3M™ FIXED ALPR SYSTEMS

A Fully Integrated Solution

3M Fixed ALPR Systems provide an array of cameras designed to fit the needs of many applications. Each system is highly configurable providing more than one average U.S. road lane coverage.

Features and Benefits

- Continuous surveillance of high-traffic areas.
- Monitoring areas of high criminal activity at a safe distance.
- Enables rapid, efficient, and appropriate deployment of resources.
- Fully integrated cameras are rugged and compact, incorporating the fixed ALPR camera, illuminator and processor within a single sealed enclosure.
- Identification and real-time enforcement of frequent toll violators.

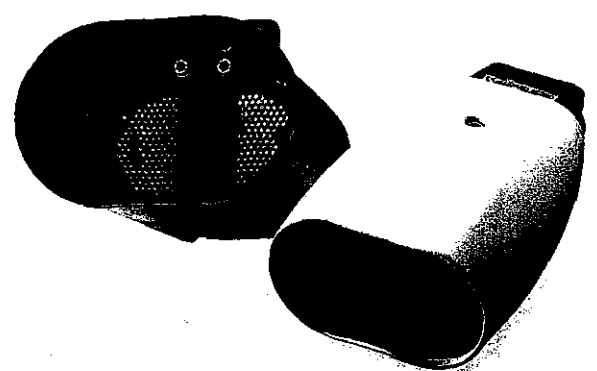

Applications

High Occupancy Toll (HOT) lanes	Access control
Congestion charging	Infrastructure monitoring
Traffic data collection for analysis of road usage	Travel time management
Parking management	Continuous surveillance of high speed or high-crime areas
Speed enforcement	

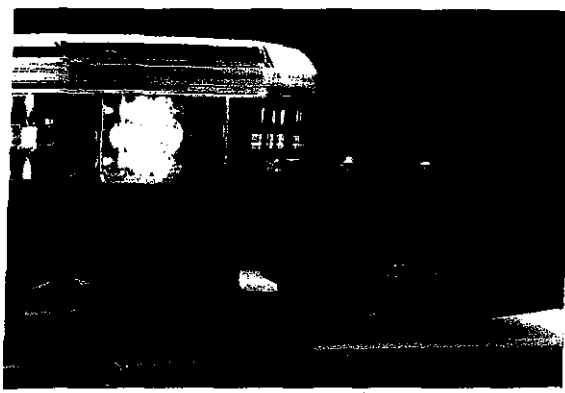

ALPR APPLICATIONS

Solve Your Road Dilemmas

- **AVERAGE SPEED ENFORCEMENT**—Paired or grouped cameras calculate speeds to aid in the decongestion of high traffic roads or increase safety in construction or school zones.
- **INTELLIGENT TRANSPORTATION SYSTEMS**—Specialized ALPR software helps solve a variety of road dilemmas including tolling enforcement and congestion charging, as well as unique applications like bus lane enforcement and traffic data collection.
- **LAW ENFORCEMENT AND SECURITY**—ALPR is the force multiplier assisting agencies around the world with stolen vehicle recovery and drug enforcement, while providing a plethora of investigative tools.
- **PARKING**—Provides automated parking facility management and security for airports, hospitals, universities, arenas, and stadiums.

ALPR WITH 3M LICENSE PLATE TECHNOLOGY

In 1947, 3M introduced the first reflective materials for license plates. Since that time, the 3M reputation for quality products has expanded globally and today, 3M reflective license plate materials are utilized on vehicles around the globe. Our historical market knowledge and government relationships provide 3M ALPR customers with a unique advantage. As license plate reissues occur, our team of 3M scientists and optical character recognition (OCR) engineers are positioned to be at the forefront of those decisions, helping to ensure new license plate designs are chosen with ALPR capabilities in mind. This provides 3M OCR engineers the ability to quickly incorporate these new design components at the state, regional, or even national level.



An
Invaluable Technology
for Our Detectives

— Lieutenant Christopher Morgan, Long Beach Police Department



CDS Office Technologies
 1271 HAMILTON PARKWAY
 Itasca, Illinois 60143
 United States
 (P) 630-677-1315
 (F) 630-305-9876

Order #: (244)
Date: Dec 04, 2014 04:36 PM CST
Doc #: 443958 - rev 1 of 1
Description: Genetec LPR w/ Patrol Only - 3 Cam. 5 yr warranty
SalesRep: Gottlieb, Mark
 (P) 630-677-1315
Customer Contact: COOPER, JOHN
 (P) 630-353-8359
 jcooper@darien.il.us

Customer
 DARIEN POLICE DEPT (24138)
 COOPER, JOHN
 1710 PLAINFIELD ROAD
 DARIEN, IL 60561
 United States
 (P) 630-971-3999

Bill To
 DARIEN POLICE DEPT
 COOPER, JOHN
 1710 PLAINFIELD ROAD
 DARIEN, IL 60561
 United States
 (P) 630-971-3999

Ship To
 DARIEN POLICE DEPT
 COOPER, JOHN
 1710 PLAINFIELD ROAD
 DARIEN, IL 60561
 United States
 (P) 630-971-3999

Customer PO:

Terms:
 Net 30

Ship Via:
 UPS Ground

Shipping Instructions:

Carrier Account #:

3-CAMERAS - QUOTE IS FOR (1) SET-UP

Qty	Unit Price	EA
1		
1 Main LPR Unit		
2		
SharpX Main Processing Unit		
	S-EQ-AU-X-XPU-X4M	1 \$7,600.00 \$7,600.00
3		
USB GPS Unit		
	S-EQ-AU-H-USBGPS	1 \$100.00 \$100.00
4		
Cameras and Accessories		
5		
AutoVu SharpX Camera, XGA w/850nm Illuminator 16mm focal length for oncoming traffic		
	S-EQ-AU-X-XGA-B16850	1 \$3,300.00 \$3,300.00
6		
AutoVu SharpX Camera, VGA w/850nm Illuminator 12mm focal length for parking		
	S-EQ-AU-X-VGA-B12850	1 \$2,500.00 \$2,500.00
7		
AutoVu SharpX Camera, VGA w/850nm Illuminator 16mm focal length for oncoming traffic		
	S-EQ-AU-X-VGA-B16850	1 \$2,500.00 \$2,500.00
8		
Mobile SharpX Camera Mounting Bracket		
	S-ACC-AU-XMNT-CAMU-B	3 \$195.00 \$585.00
9		
7m Camera Cable		
	S-ACC-AU-H-CBL07	3 \$195.00 \$585.00
10		
Software		
11		
GSC AutoVu Standard Base Package Includes SQL 2008 Express Edition, works with Genetec Security Center		
	V-SW-GSC-Av-S	1
12		
Microsoft Virtual Earth/Bing Map License		
	M-SW-AU-M-MSBINGNA	1
13		
Mapping License for North America		
	S-SW-AU-M-OFFLINEMAP-NA	1
14		
Genetec Security Center BOF, 5-User Licenses Note: Alarm Management, Advanced Reporting, System Partitioning, Zone Monitoring, Email Support		
	V-SW-GSC-Base-5.2	1
15		
One Patroller Connection In-vehicle software		
	S-SW-GSC-Av-S-1PATROLLER	1
16		
AutoVu Patroller Software Per Vehicle Software License		
	S-SW-AU-P-MIBASE	1
17		
Bundle Subtotal		
		1 \$1,700.00 \$1,700.00

		Qty	Unit Price	Total
18 Software Maintenance				
19 Software Management Agreement - Base Package 1 Year for In-Vehicle Patroller Software	S-SVC-SMA-1PATR-1Y	1		
20 Software Management Agreement - Base Package 1 Year for In-Station Security Center Software	S-SVC-SMA-BASE-1Y	1		
21 Bundle Subtotal		1	\$600.00	\$600.00
22 Installation & Training				
23 Software/Hardware installation & training On site hardware installation, remote server installation, Train the Trainer on server and in vehicle software and hardware	TK-IO-CUSTINS	1	\$1,500.00	\$1,500.00
24 Extended Warranty				
25 Extended Warranty for SharpX system with Three Cameras - 5 Year Return & Repair Coverage of AutoVu Hardware (first year included - coverage for 4 additional years)	S-SVC-AU-K-X-3CAM-EWRR-P5	1	\$5,475.00	\$5,475.00

Subtotal:	\$26,445.00
Tax (8.500%):	\$0.00
Shipping:	\$0.00
Total:	\$26,445.00

CDS Office Technologies disclaims any responsibility for product information and products described on this site. Some product information may be confusing without additional explanation. All product information, including prices, features, and availability, is subject to change without notice. Applicable taxes & shipping may be added to the final order. CREDIT CARD ORDERS WILL BE CHARGED A 2.75% CONVENIENCE FEE FOR PROCESSING THE ORDER. All returns must be accompanied by original invoice and authorized RMA number within 30 days of invoice date and are subject to a 15% restocking fee. Late fees may apply to payments past 30 days from invoice date. Please contact your sales representative if you have any questions.



CDS Office Technologies
 1271 HAMILTON PARKWAY
 Itasca, Illinois 60143
 United States
 (P) 630-677-1315
 (F) 630-305-9876

Quotation (Open)
Date
 Dec 04, 2014 04:18 PM CST
Doc #
 443957 - rev 1 of 1
Description
 Genetec LPR w/ Patrol Only - 3 Cam. 3 yr warranty
SalesRep
 Gottlieb, Mark
 (P) 630-677-1315
Customer Contact
 COOPER, JOHN
 (P) 630-353-8359
 jcooper@darien.il.us

Customer
 DARIEN POLICE DEPT (24138)
 COOPER, JOHN
 1710 PLAINFIELD ROAD
 DARIEN, IL 60561
 United States
 (P) 630-971-3999

Bill To
 DARIEN POLICE DEPT
 COOPER, JOHN
 1710 PLAINFIELD ROAD
 DARIEN, IL 60561
 United States
 (P) 630-971-3999

Ship To
 DARIEN POLICE DEPT
 COOPER, JOHN
 1710 PLAINFIELD ROAD
 DARIEN, IL 60561
 United States
 (P) 630-971-3999

Customer PO:

Terms:
 Net 30

Ship Via:
 UPS Ground

Shipping Instructions:

Carrier Account #:

Qty	Unit Price	Price
1 Main LPR Unit		
2	SharpX Main Processing Unit	S-EQ-AU-X-XPU-X4M 1 \$7,600.00 \$7,600.00
3	USB GPS Unit	S-EQ-AU-H-USBGPS 1 \$100.00 \$100.00
4 Cameras and Accessories		
5	AutoVu SharpX Camera, XGA w/850nm Illuminator 16mm focal length for oncoming traffic	S-EQ-AU-X-XGA-B16850 1 \$3,300.00 \$3,300.00
6	AutoVu SharpX Camera, VGA w/850nm Illuminator 12mm focal length for parking	S-EQ-AU-X-VGA-B12850 1 \$2,500.00 \$2,500.00
7	AutoVu SharpX Camera, VGA w/850nm Illuminator 16mm focal length for oncoming traffic	S-EQ-AU-X-VGA-B16850 1 \$2,500.00 \$2,500.00
8	Mobile SharpX Camera Mounting Bracket	S-ACC-AU-XMNT-CAMU-B 3 \$195.00 \$585.00
9	7m Camera Cable	S-ACC-AU-H-CBL07 3 \$195.00 \$585.00
10 Software		
11	GSC AutoVu Standard Base Package Includes SQL 2008 Express Edition, works with Genetec Security Center	V-SW-GSC-Av-S 1
12	Microsoft Virtual Earth/Bing Map License	M-SW-AU-M-MSBINGNA 1
13	Mapping License for North America	S-SW-AU-M-OFFLINEMAP-NA 1
14	Genetec Security Center BOF, 5-User Licenses Note: Alarm Management, Advanced Reporting, System Partitioning, Zone Monitoring, Email Support	V-SW-GSC-Base-5.2 1
15	One Patroller Connection In-vehicle software	S-SW-GSC-Av-S-1PATROLLER 1
16	AutoVu Patroller Software Per Vehicle Software License	S-SW-AU-P-MIBASE 1
17	Bundle Subtotal	1 \$1,700.00 \$1,700.00

		Qty	Unit Price	Total
18 Software Maintenance				
19 Software Management Agreement - Base Package 1 Year for In-Vehicle Patroller Software	S-SVC-SMA-1PATR-1Y	1		
20 Software Management Agreement - Base Package 1 Year for In-Station Security Center Software	S-SVC-SMA-BASE-1Y	1		
21 Bundle Subtotal		1	\$600.00	\$600.00
22 Installation & Training				
23 Software/Hardware installation & training On site hardware installation, remote server installation, Train the Trainer on server and in vehicle software and hardware	TK-IO-CUSTINS	1	\$1,500.00	\$1,500.00
24 Extended Warranty				
25 Extended Warranty for SharpX system with Three Cameras - 3 Year Return & Repair Coverage of AutoVu Hardware (first year included - coverage for 2 additional years)	S-SVC-AU-K-X-3CAM-EWRR-P3	1	\$3,125.00	\$3,125.00

Subtotal:	\$24,095.00
Tax (8.500%):	\$0.00
Shipping:	\$0.00
Total:	\$24,095.00

CDS Office Technologies disclaims any responsibility for product information and products described on this site. Some product information may be confusing without additional explanation. All product information, including prices, features, and availability, is subject to change without notice. Applicable taxes & shipping may be added to the final order. CREDIT CARD ORDERS WILL BE CHARGED A 2.75% CONVENIENCE FEE FOR PROCESSING THE ORDER. All returns must be accompanied by original invoice and authorized RMA number within 30 days of invoice date and are subject to a 15% restocking fee. Late fees may apply to payments past 30 days from invoice date. Please contact your sales representative if you have any questions.



CDS Office Technologies
 1271 HAMILTON PARKWAY
 Itasca, Illinois 60143
 United States
 (P) 630-677-1315
 (F) 630-305-9876

Customer (CDS)
Date
 Nov 20, 2014 03:48 PM CST
Doc #
 443786 - rev 1 of 1
Description
 Genetec LPR w/ Patrol Only - 3 Cam, 1 yr warranty
SalesRep
 Gottlieb, Mark
 (P) 630-677-1315
Customer Contact
 COOPER, JOHN
 (P) 630-353-8359
 jcooper@darien.il.us

Customer
 DARIEN POLICE DEPT (24138)
 COOPER, JOHN
 1710 PLAINFIELD ROAD
 DARIEN, IL 60561
 United States
 (P) 630-971-3999

Bill To
 DARIEN POLICE DEPT
 COOPER, JOHN
 1710 PLAINFIELD ROAD
 DARIEN, IL 60561
 United States
 (P) 630-971-3999

Ship To
 DARIEN POLICE DEPT
 COOPER, JOHN
 1710 PLAINFIELD ROAD
 DARIEN, IL 60561
 United States
 (P) 630-971-3999

Customer PO:

Terms:
 Net 30

Ship Via:
 UPS Ground

Shipping Instructions:

Carrier Account #:

Item #	Description	Part #	Qty	Unit Price	Total Price
1	Main LPR Unit				
2	SharpX Main Processing Unit	S-EQ-AU-X-XPU-X4M	1	\$7,600.00	\$7,600.00
3	USB GPS Unit	S-EQ-AU-H-USBGPS	1	\$100.00	\$100.00
4	Cameras and Accessories				
5	AutoVu SharpX Camera, XGA w/850nm Illuminator 16mm focal length for oncoming traffic	S-EQ-AU-X-XGA-B16850	1	\$3,300.00	\$3,300.00
6	AutoVu SharpX Camera, VGA w/850nm Illuminator 12mm focal length for parking	S-EQ-AU-X-VGA-B12850	1	\$2,500.00	\$2,500.00
7	AutoVu SharpX Camera, VGA w/850nm Illuminator 16mm focal length for oncoming traffic	S-EQ-AU-X-VGA-B16850	1	\$2,500.00	\$2,500.00
8	Mobile SharpX Camera Mounting Bracket	S-ACC-AU-XMNT-CAMU-B	3	\$195.00	\$585.00
9	7m Camera Cable	S-ACC-AU-H-CBL07	3	\$195.00	\$585.00
10	Software				
11	GSC AutoVu Standard Base Package Includes SQL 2008 Express Edition, works with Genetec Security Center	V-SW-GSC-Av-S	1		
12	Microsoft Virtual Earth/Bing Map License	M-SW-AU-M-MSBINGNA	1		
13	Mapping License for North America	S-SW-AU-M-OFFLINEMAP-NA	1		
14	Genetec Security Center BOF, 5-User Licenses Note: Alarm Management, Advanced Reporting, System Partitioning, Zone Monitoring, Email Support	V-SW-GSC-Base-5.2	1		
15	One Patroller Connection In-vehicle software	S-SW-GSC-Av-S-1PATROLLER	1		
16	AutoVu Patroller Software Per Vehicle Software License	S-SW-AU-P-MIBASE	1		
17	Bundle Subtotal		1	\$1,700.00	\$1,700.00

	Part	Qty	Unit Price	Total
18 Software Maintenance				
19 Software Management Agreement - Base Package 1 Year for In-Vehicle Patroller Software	S-SVC-SMA-1PATR-1Y	1		
20 Software Management Agreement - Base Package 1 Year for In-Station Security Center Software	S-SVC-SMA-BASE-1Y	1		
21 Bundle Subtotal		1	\$600.00	\$600.00
22 Installation & Training				
23 Software/Hardware installation & training On site hardware installation, remote server installation, Train the Trainer on server and in vehicle software and hardware	TK-IO-CUSTINS	1	\$1,500.00	\$1,500.00
24 Extended Warranty				
25 Extended Warranty for SharpX system with Three Cameras - 1 Year Return & Repair Coverage of AutoVu Hardware (coverage for second year)	S-SVC-AU-K-X-3CAM-EWRR-1Y	1	\$1,800.00	\$1,800.00

Subtotal:	\$22,770.00
Tax (8.500%):	\$0.00
Shipping:	\$0.00
Total:	\$22,770.00

CDS Office Technologies disclaims any responsibility for product information and products described on this site. Some product information may be confusing without additional explanation. All product information, including prices, features, and availability, is subject to change without notice. Applicable taxes & shipping may be added to the final order. CREDIT CARD ORDERS WILL BE CHARGED A 2.75% CONVENIENCE FEE FOR PROCESSING THE ORDER. All returns must be accompanied by original invoice and authorized RMA number within 30 days of invoice date and are subject to a 15% restocking fee. Late fees may apply to payments past 30 days from invoice date. Please contact your sales representative if you have any questions.

John Cooper

From: Mark Gottlieb <mgottlieb@cdsot.com>
Sent: Thursday, December 4, 2014 4:45 PM
To: John Cooper
Subject: LPR with warranty options
Attachments: Quote #443958.pdf; Quote #443786.pdf; Quote #443957.pdf

John,

I mentioned the other day in my message that Wood Dale was moving forward with their LPR purchase and we had found a couple other warranty options that are available. Attached are three quotes, the initial one with a one year warranty and then two more with three and five year options.

For a system that sits outside in the elements 24/7 it's certainly nice to have extended warranty options available and these do have to be purchased at the initial time of the sale

Thanks!

Mark Gottlieb
Account Manager



1271 Hamilton Pkwy | Itasca, IL 60143
630-677-1315 (c) | 630-625-4519 (w) | 630-305-9876 (f)
mgottlieb@cdsot.com | www.cdsot.com

State of IL Master Contract

Panasonic Toughbooks – CMS5848520

Panasonic Arbitrator – CMS5848520

Lenovo Desktop Computers - CMS1560940A



Genetec

IP-Based License Plate Recognition
for Law Enforcement

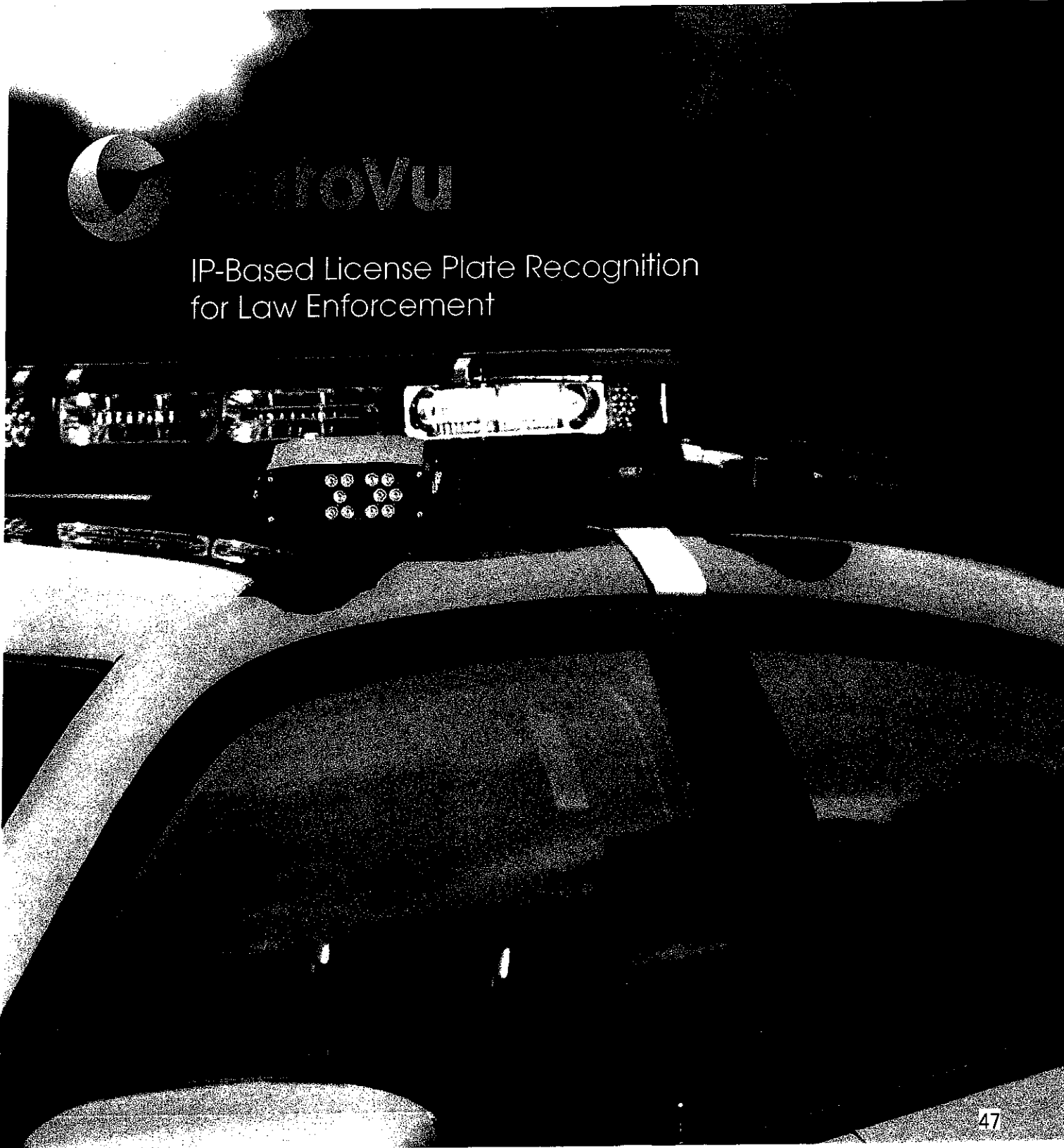

Advancements in license plate recognition (LPR) technology have enabled police agencies worldwide to apprehend more wanted suspects and recover more stolen vehicles, all while improving the safety of those on duty. Choosing the right LPR system, though, is vital to ensure a reliable solution to detect suspected vehicles and potential threats.



Genetec AutoVu provides officers the most accurate and reliable LPR system in the industry, ensuring that thousands of plates can be read effortlessly during each shift. Available as both **fixed and mobile** camera systems, AutoVu has been engineered, tested, and proven to meet the demands of law enforcement applications.

AutoVu System Overview

Hardware

The AutoVu Sharp family of IP-based LPR devices leads the industry in license plate read rates, ensuring an effective solution for police operations. The Sharp and SharpX are designed to provide the most accurate plate reads every shift, more plate reads in bad weather, or at poor angles, and even at high speeds. From vehicle mounted systems to fixed perimeter installations, AutoVu enables organizations to automate license plate identification, and share critical data amongst officers.

AutoVu SharpX

- Plate capture across three lanes of traffic
- Up to 5,000 plate captures per minute
- Plate capture up to differential speeds of 200 MPH (320 km/h)
- Smallest high-resolution LPR camera on the market



AutoVu Sharp

- Easily portable from vehicle-to-vehicle
- On-board video compression and analytics
- Plate capture up to differential speeds of 140 MPH (225 km/h)
- All-in-one solution with limited wiring required



Software

AutoVu Patroller is the intuitive in-vehicle control interface of the AutoVu system, providing easily accessible features for officers onboard, and allowing them to monitor incoming reads from LPR cameras. With touch-enabled functions, training on the system is easy for operators of all levels of technical experience.

Security Center is Genetec's unified security platform that provides real-time monitoring of AutoVu events, alarm management, as well as advanced data-mining and reporting capabilities. As license plate reads and hits are gathered from patrolling units in the field and from fixed AutoVu Sharp units, information is relayed to Security Center operators. In the case of fixed applications, not only can operators monitor the incoming reads from LPR cameras, but can also view live video that is captured from the Sharp camera.

AUTOVU PATROLLER ▶
On-board navigation and monitoring interface. LPR information can be sent to Security Center in real-time through live transmission.

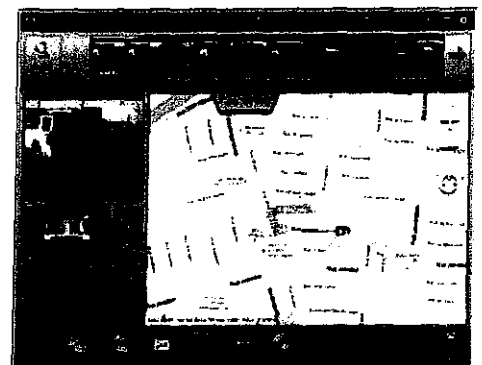

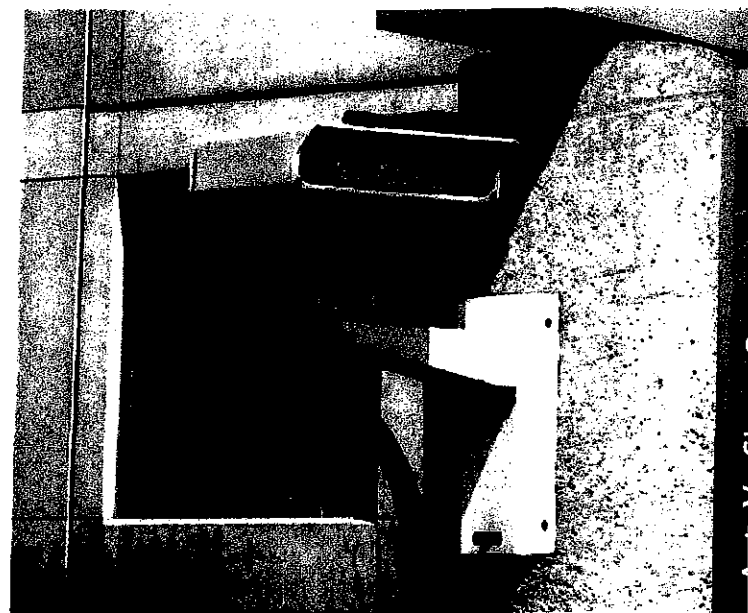
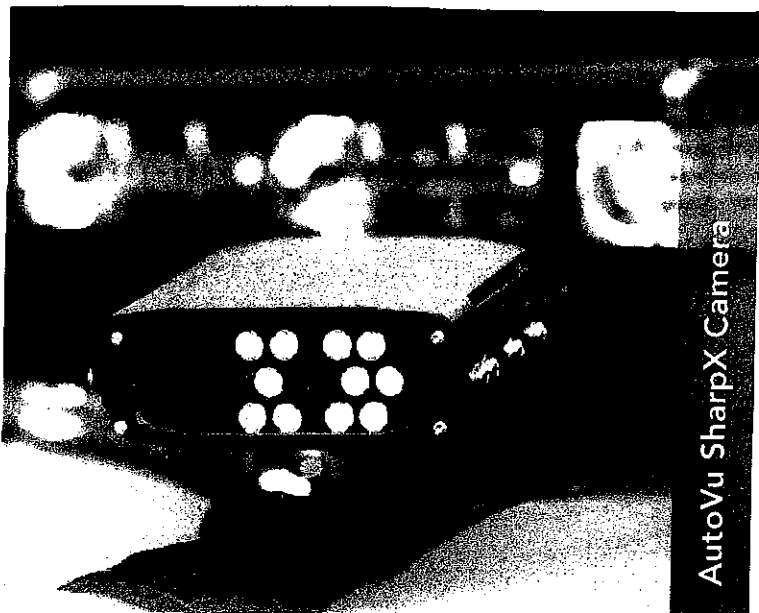

5 Reasons For Choosing AutoVu

Highest Accuracy Rate in the Industry

Backed by over 15 years' experience in LPR technology development, and the highest plate capture and recognition rates in the industry, police agencies trust AutoVu to identify all license plates within the camera's field of view. By combining state-of-the-art IP-based LPR cameras and advanced software features, AutoVu ensures highly-accurate verification analysis to provide officers with the best possible match of every license plate and to maximize wanted-vehicle identification within databases of vehicles of interest.

Ease of Use

AutoVu is designed to automate and simplify the verification of license plates against multiple hotlists, increasing the safety of officers on patrol with a non-intrusive application that allows them to focus on other critical tasks, while alerting them, and the backoffice, when threats are detected. To ensure that operators feel at ease with this LPR system, AutoVu provides a user-friendly interface and features, including touch-enabled functions, graphical maps, associated image and time captures on every read.

Purpose-Built, Real-Time Surveillance

With LPR cameras engineered to meet the demands of fixed and mobile law enforcement operations, and an advanced feature set to support officers on duty, the AutoVu system is an ideal choice for police agencies, requiring a field-proven LPR solution. Because AutoVu is IP-based, users get real-time surveillance and identification of plates, while officers can also monitor the live update of LPR information using the Security Center client.

Deploy as a Standalone or Think Bigger

AutoVu can easily be deployed as either a standalone system, or incorporated within a greater security and surveillance environment. Unification with video surveillance and access control systems is made easy within the Security Center platform and its video and access control modules, Omnicast, and Synergis. Through this single application, cities and police agencies can manage and monitor their LPR and video surveillance feeds, generate consolidated reports and centralize their alarm management.

Advanced Reporting and Data Mining Capabilities

When reviewing plate reads or when receiving new wanted vehicle identifications, officers can easily search for full or partial license plates from their vehicle. Operators can rapidly review each hit corresponding to searches, as well as any associated data, including geographic coordinates.

With Security Center, users can generate a myriad of LPR-related reports that are highly intuitive and provide operators with a great deal of flexibility, allowing them to filter results based on date, time, patrolling unit, hotlist or area, and much more. Daily usage statistics and logon reports can also be queried to retrieve hit and read statistics, route playback data, and inventory information. Through the use of graphical displays, data is visualized and easily understood, as it is overlaid atop of maps pinpointing each read, hit, and vehicle coordinates.

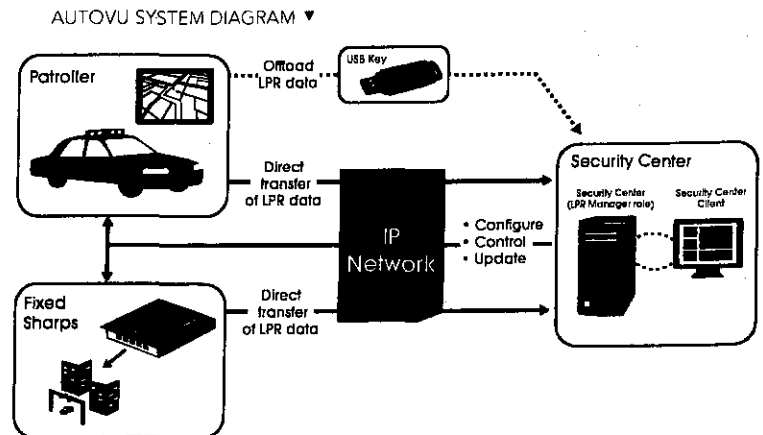

AutoVu License Plate Recognition Key Features

Fuzzy Matching	Due to environmental factors, such as dirt or snow accumulation on license plates, errors sometime occur in a read. The fuzzy matching feature enhances verification within AutoVu to ensure that even if a read is imperfect, operators are still getting the best possible matches of every license plate to the database of vehicles of interest. Fuzzy matching analyzes incomplete license plate reads, containing one or more errors, against a hotlist and alerts the officer in case of any potential matches.
In-Vehicle Mapping	AutoVu is equipped with intuitive graphical features, including in-vehicle mapping, to help ensure accuracy and ensure operators can remain effective while on duty. Accessible from within the vehicle or the backoffice, map displays provide operators an easier method to not only visualize the location of a read but also generates a specific location such as a street address.
Wildcard Hotlists	When only partial license plate numbers are available to identify a suspect vehicle, officers can create a wildcard hotlist database in order to rapidly identify potential hits. Notifications of hotlist hits can be identified with different sounds, colors, and priority assignments than those of definite matches.
Covert Hotlists	Covert hotlists are available to ensure the discretion of an on-going investigation or special operation. When a hit is identified, only the authorized officer at the Security Center station will be notified, while the in-vehicle patroller will not be alerted. This enables enforcement officials to assign multiple objectives to the vehicle and backend systems, while not interrupting the priorities of officers on duty.
Automatic Events and Alarms	Officers can receive automated alarms and events from the AutoVu system when a black-listed, wanted, or stolen vehicle is detected. This allows officials to prioritize and respond to the events deemed most urgent.
Live Data Transmission	The AutoVu system ensures officers are kept up-to-date with the latest information through the live update of LPR reads and hits. Using the Security Center client, officers can remotely monitor one or more Patroller units, fixed Sharp cameras, or specific hotlists in real-time.
Third-Party System Integration	Through its advanced SDK, AutoVu can integrate with other software applications to fit within existing workflows and operational processes.

Put AutoVu to the test with the new **Pilot to Purchase Program!**

You can now get hands-on experience with the market's leading LPR technology at no cost. Through Genetec's new pilot program, law enforcement agencies can now receive a free trial of AutoVu to test on their vehicle.

For more details, and to participate in the Pilot to Purchase Program, contact us at sales@genetec.com

WHAT'S INCLUDED

- A multi-camera LPR system with in-vehicle and back-office software for 60 days*
 - Full installation of software, vehicle equipment, and operator training
 - Technical and field support for 60 days
- * Customers must supply their own in-vehicle computer and back-end server.

For full technical specifications see:

- AutoVu SharpX Camera Data Sheet
- AutoVu Sharp Camera Data Sheet

Genetec

License Plate Recognition | Video Surveillance | Access Control

2280 Alfred-Nobel Blvd., Suite 400, Montreal, QC, Canada H4S 2A4
T 514.332.4000 F 514.332.1692 | genetec.com | info@genetec.com

AGENDA MEMO
Police Committee
January 19, 2015

ISSUE STATEMENT

Staff is requesting to purchase additional equipment to be used with the TI firearms training simulator using Department of Justice Award Money.

BACKGROUND/HISTORY

In FYE 14 the department purchased a TI firearms training simulator to train officers in critical decision making and use of firearms during confrontations with offenders. Staff is looking to add additional equipment that will allow (2) to participate in scenarios at the same time which is realistic based on department responses to calls.

Staff is looking to add a second handgun, a rifle kit, a TASER, OC Canister, and extra magazines for the pistol.

STAFF/COMMITTEE RECOMMENDATION

The Staff recommends that the Police Committee approve the purchase of the additional equipment in the amount of \$10,050.00 from TI Training Labs.

ALTERNATE CONSIDERATION

Not to purchase the additional equipment at this time.

DECISION MODE

This item will be placed on the February 2, 2015, City Council agenda for formal consideration.

CITY OF DARIEN
Police Department
MEMO

TO: Ernest Brown

FROM: Sgt. James Topel

DATE: 12/28/14

SUBJ: TI Training Lab Equipment Options

The following is a list of equipment options that are attached to Darien PD duty weapons to allow them to be used in the TI Training Lab. A majority of the scenarios in the training lab are two officer responses. The following equipment will allow for a second officer to actively participate in the scenario. In addition is a list of equipment options that was not included in the standard training lab that will allow officers to select the appropriate equipment for the scenario.

Equipment options to allow a second officer to actively participate in the scenario.

Recoil Kit for Glock handgun	\$2900
Resetting Glock Trigger Kit	\$300
Additional Glock 22 Magazine	\$300
OC Laser Canister	\$1400
Flashlight with Filter	\$250
Total	\$5150

Equipment options that were not included with the original TI Training Lab purchase.

Recoil Kit for Rifle	\$2900
X2 Taser Package	\$2600
Additional Glock 22 Magazine	\$300
Total	\$5,800

Grand total \$10,950

I spoke with Kila at TI Training. Ti will give \$500 credit for the movie screen we are not using and an additional \$400 discount if the above equipment is purchased.
\$10,950 - \$900= \$10,050. The shipping to return the screen is approx: \$100

AGENDA MEMO
Police Committee
January 19, 2015

ISSUE STATEMENT

Staff is requesting to purchase 40 gas masks from Pro-Tech Sales using Department of Justice Award Money.

BACKGROUND/HISTORY

The police department equips its officers with gas masks to be used during tactical incidents and for escape from a hot zone in a terrorist attack.

In FYE 15 Budget, Staff requested to replace the police department's gas masks. The old gas masks have reached the end of their service life. It was decided that DOJ Award Money would be used for this purchase.

STAFF/COMMITTEE RECOMMENDATION

The Staff is requesting to purchase (40) AVON C50 Gas Masks and filters to be issued to all the sworn officers. Pro-Tech Sales is offering a \$100.00 trade in on our old masks. When obtaining additional quotes for these masks, no other company could come close to the PRO-TECH pricing with the generous trade-in allowance.

Staff recommends the purchase of (40) AVON C50 Gas Masks from PRO-TECH for the amount of \$13,160.00 using DOJ Award money. There will be an additional cost to have corrected lenses added to the RX holder. Staff is looking for the best deal on this.

ALTERNATE CONSIDERATION

Not to purchase the gas masks at this time.

DECISION MODE

This item will be placed on the February 2, 2015, City Council agenda for formal consideration.

VENDOR PROPOSAL

DATE: 1/19/2015

REQUEST TYPE: _____ REPLACEMENT Yes OTHER _____

ITEM: AVON C50 gas mask and respirator ANTICIPATED FUNDING SOURCE: DOJ award Funds

HISTORY OF REQUEST:

The PD currently equips each officer with a personally fitted gas mask and respirator. The masks are used in the event of tear gas deployment for crowd control and in the event of certain types of terrorist and hazardous materials incidents. The current gas masks have reached their viable service life and no longer provide the protection required for such incidents. The PD is therefore seeking to replace those masks with new ones. There were two companies researched and limited price competition.

	#1	#2	#3
VENDOR	Streicher's	PRO-TECH	
ITEM	Avon C50	Avon C50-Lens clear	
	Lens Clear-CBRN Canister Filter	Respirator Canister-CBRN	
	Vision Correction -Pouch	Corrective lens-Carrie pouch	
SPECIFICATIONS			
WARRANTY			
EXTENDED WARR.			
MAINT. COSTS			
LIFE EXPECT.			
PRICE	\$22,383.00	\$13,160.00	



STREICHER'S
service since 1953

SALES QUOTE

www.PoliceHQ.com

Streicher's - Milwaukee
4777 N 124th St
Butler, WI 53007
Phone: 262-781-2552
Fax: 262-781-0444

Sales Quote Number: Q306416
Sales Quote Date: 01/15/15
Page: 1

Sell 44343
To: DARIEN POLICE DEPT.
1710 PLAINFIELD RD
ATN: CHIEF BROWN
DARIEN, IL 60561-

Ship
To: DARIEN POLICE DEPT.
1710 PLAINFIELD RD
ATN: CHIEF BROWN
DARIEN, IL 60561-

Phone: (630) 971-3999
Fax: (630) 971-4326

Ship Via
Terms Net 15

SalesPerson Ed Marben
Phone: 262-781-2552
E-mail: edm@PoliceHQ.com

Item No.	Description	Unit	Quantity	Unit Price	Total Price
AV-C50T.M	Gas Mask: Avon C50 CBRN Twin-Port, Medium Size specific.	EA	40	315.00	12,600.00
AV-70501.155	VISION: C50, FM50, FM53 Vision Correction Assembly	EA	20	56.99	1,139.80
AV-COS	LENS: Clear Outsert Assembly for C50, FM53, FM50(Acces)	EA	40	48.99	1,959.60
DF-TRGMP1K	Gas Mask Pouch: Large Size, Black	EA	40	44.99	1,799.60
AV-CBRNF12.4	Canister Filter: CBRN for FM12 (Pack of 4) Sold in a 4 pack only	EA	10	265.00	2,650.00
FRT	Shipping, Handling & Insurance	EA	1	75.00	75.00

Quoted prices do not include Sales Tax. All quoted prices are valid for 60 days from the date of the quote.

Total: 20,224.00



AGT Tactical

Only The Best. For America's Finest

HOME REGISTER SIGN IN SHOPPING CART CONTACT US SEARCH



Our Products >> Gas Masks And Accessories >> C50 Masks And Accessories >> C50 Mask

C50 Mask

* Marked fields are required

Size

Qty*

Price \$409.30

ADD TO CART



Manufacturer: Avon Protection
Manufacturer's Product Number:
70501-188

Be the first to write a review

OUR PRODUCTS

[Food & Water](#)

[Gas Masks And Accessories](#)

[C50 Masks And Accessories](#)

[FM50 Mask And Accessories](#)

[FM53 Mask And Accessories](#)

[Special Deals](#)

[Weapons & Accessories](#)

[Offgrid Power](#)

[Shelter](#)

[Blog](#)

[Free Downloads Available With Your Order](#)

PAYPAL BILL ME LATER

Get more time to pay
Check out with PayPal and choose PayPal Credit. Subject to credit approval. See below for restrictions.

VERIFIED & SECURE WEBSITE

Secured by **PayPal**
How PayPal Works

VERIFIED & SECURED
VERIFY SECURITY

Please share on Twitter and Facebook!
Tweet

AFFILIATES

For the ultimate shelter:

<http://www.intershelter.com/>

For the ultimate gear tags:

<http://www.baqtaqz.net/>

The Avon C50 Twin Port Mask, based on the Avon Protection JSGPMM50 mask, has been developed to meet the respiratory protection needs of law enforcement, corrections officers, SWAT, and first responders.

Mask includes: Mask, Faceform 72601-53, C50 User Manual 70501-84, and Storage Bag 71521-1. No filters, outserts, etc. are included. To save money, you'll do much better ordering the C50 First Responder Kit, which includes more items at lower cost.

C50 options include a panoramic flexible visor, dark visor, Voice Projection Unit (VPU) with Microphone, EZ Air Unit, high-flow fail-safe hydration device, etc (sold separately). The C50 is NIOSH CBRN Cap 1 approved with the CBRNF12B filter and NIOSH 42 CFR 84 not control CS-CN-P100 approved with the CTF12 filter (sold separately). The C50 also meets the latest NATO military standards. The filter side can be changed using Filter Mount Plug Tool (70501-161, not included). Large Item Number: 70501-187, Medium Item Number: 70501-188, Small Item Number: 70501-189.

[C50 Brochure](#)

[C50 Comparison](#)

Reviews (0) [Write a Review](#)

No Reviews. [Write a Review](#)

322.50
240

20,883.6

\$1500

\$22,383

Terms and Conditions About Us Help Site Map
Copyright © 2004-2015 AGT Tactical. All rights reserved.

Lock. Load.





AGT Tactical

Only The Best, For America's Finest

HOME REGISTER LOGIN SHIPPING INFO CONTACT US SEARCH



Our Products >> [Gas Masks And Accessories](#) >> [C50 Masks And Accessories](#) >> [CBRNF12B Filter](#)

CBRNF12B Filter

* Marked fields are required

Qty*

Price \$61.05

[ADD TO CART](#)



Manufacturer: Avon Protection
Manufacturer's Product Number: 71510-1

[Be the first to write a review](#)

OUR PRODUCTS

[Food & Water](#)

[Gas Masks And Accessories](#)

[C50 Masks And Accessories](#)

[FM50 Mask And Accesories](#)

[FM53 Mask And Accessories](#)

[Special Deals](#)

[Weapons & Accessories](#)

[Offroad Power](#)

[Shelter](#)

[Blog](#)

[Free Downloads Available With Your Order](#)

PAYPAL BILL ME LATER

Get more time to pay
Check out with PayPal and choose PayPal Credit. Subject to credit approval. See terms. US residents only.

VERIFIED & SECURE WEBSITE

How PayPal Works

Please share on Twitter and Facebook!

[Tweet](#) 2

AFFILIATES

For the ultimate shelter:

<http://www.intershelter.com/>

For the ultimate gear tags:

<http://www.bagtagz.net/>

ONE ONE LEFT IN STOCK! NIOSH certified for use with Avon C50, FM12, FM53 and C420 PAPR. Dual classification for industrial TICs & TIMs and CBRN agents. Particulate hazards including dust, mist, bacteria and virus plus all NIOSH specified CBRN gases and vapors including nerve, blood, choking and blister agents. For the FM53, C50, C420, FM12 Masks, and any other mask using 40mm threads. Please note: If you have an Avon C50 or FM53 mask, we highly recommend the GPCF50 Low Profile Conformal Filter. The GPCF50 provides the same protection in a low profile design (works only with Avon C50 and Masks masks however...see description on this website).

- Classification: CBRN Cap 1
- Weight (Aprox): 320g
- Breathing Resistance (aprox): 41mm H2O at 85 l/min
- Packing: Foil
- Shelf Life (if left in packaging): 5 years
- Filter Body Style: Standard

- Specifications:
- Classification: Mil Spec
 - Weight (approx): 280g
 - Breathing Resistance (approx): 40mm H2O at 85 l/min
 - Packing: Foil
 - Filter Body Style: Conformal

- Suitable Protection Against:
- Ammonia
 - Arsenic
 - Asbestos
 - Bacteria
 - Benzene
 - Blister Agent
 - Blood Agent
 - Bromine
 - Carbon Dioxide
 - Carbon Disulphide
 - Carbon Monoxide
 - Carbon Tetrachloride
 - Chlorine
 - Chlorine Dioxide
 - Chloroacetophenone (CN)
 - Chloropicrin
 - o-Chlorobenzylidene Malononitrile (CS)
 - Cyanogen
 - Cyanogen Chloride (CK)
 - Cyclohexane
 - Fluorine
 - Formaldehyde
 - Hydrogen Chloride
 - Hydrogen Cyanide (AC)
 - Hydrogen Sulfide
 - Lewisite
 - Mustard (HD)
 - Nerve Agent
 - Nitrogen Dioxide
 - Nuisance Dusts
 - Nuisance Odors
 - Oleoresin Capsicum (OC, Pepper Gas)
 - Organic Vapors w/ Boiling Point >65 Degree C
 - Particulates
 - Phosgene
 - Phosphine
 - Radioactive Particulates
 - Sarin (GB)
 - Soman (GD)
 - Sulfur Dioxide
 - Tabun (GA)

- Toluene
- Virus
- VX
- Xylene

Reviews (0) [Write a Review](#)

No Reviews. [Write a Review](#)

[Terms and Conditions](#) [About Us](#) [Help](#) [Site Map](#)
Copyright © 2004-2015 AGT Tactical. All rights reserved.





AGT Tactical

Only The Best. For America's Finest

[HOME](#) [REGISTER](#) [SIGN IN](#) [SHOPPING CART](#) [CONTACT US](#) [SEARCH](#)



[Our Products](#) >> [Gas Masks And Accessories](#) >> [Clear Outsert](#)

Clear Outsert

* Marked fields are required.

Qty*

Price \$54.80

2 or more \$51.74 each

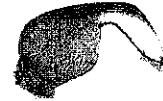

Manufacturer: Avon Protection
Manufacturer's Product Number:
70501-156

[Be the first to write a review](#)

OUR PRODUCTS

- [Food & Water](#)
- [Gas Masks And Accessories](#)
- [C50 Masks And Accessories](#)
- [FM50 Mask And Accessories](#)
- [FM53 Mask And Accessories](#)
- [Special Deals](#)
- [Weapons & Accessories](#)
- [Offroad Power](#)
- [Shelter](#)
- [Blog](#)
- [Free Downloads Available With Your Order](#)

PAYPAL BILL ME LATER

Get more time to pay
Check out with PayPal
and choose PayPal Credit.
Subject to credit approval.
See details. US customers only.

VERIFIED & SECURE WEBSITE

Secured by **PayPal**
[How PayPal Works](#)

GO DADDY
VERIFIED & SECURED
VERIFY SECURITY

Please share on Twitter and Facebook!
 2

AFFILIATES

For the ultimate shelter:
<http://www.intershelter.com/>

For the ultimate gear tags:
<http://www.bagtagz.net/>

Clear protection to prevent scratches on your mask's visor. A must have item for operations in low light conditions. Will fit FM50/FM50, C50, and FM53 masks. Constructed from the same material as the dark outsert (70501-157) for improved ballistics and abrasion resistance. Provided with Outsert Pouch (72601-28) for storage and lens cleaning.

Reviews (0) [Write a Review](#)

No Reviews. [Write a Review](#)

[Terms and Conditions](#) [About Us](#) [Help](#) [Site Map](#)
Copyright © 2004-2015 AGT Tactical. All rights reserved.

Lock. Load.

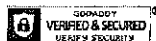



ADVANCE WITH CONFIDENCE

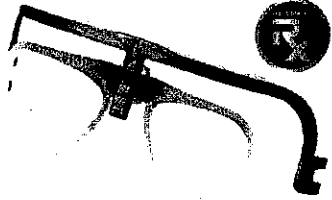

Avon 50 Series Rx Insert \$50.00

IMPORTANT NOTES

ESS GUARANTEE

Avon Rx Filling Service

Having troubles reading your prescription or completing this form? Please contact ESS at 877-725-4072 or csinfo@esseyepro.com before placing your order

ESS RX FILLING SERVICE: GETTING STARTED

Prescription Lens Options Review Add To Cart



Shipping Notice

Rx fills can only be shipped to the U.S. and Canada at this time.



Please have a copy of your Rx Form handy

ESS will require a copy of it in order to complete your order. At the end of the order process, you will be prompted to upload your Rx Form via File Upload, Email, or Fax.

GET STARTED

Avon | AEF Protection Home | View Cart

© 2015 ESS a Subsidiary of Oakley, Inc. All Rights Reserved | Website Design by Montana Banana



CITY OF DARIEN
Police Department
MEMO

TO: Members of the Police Committee
FROM: Chief Ernest Brown
DATE: January 19, 2015
SUBJ: Radar Speed Sign

The Darien Police Department purchased a radar speed sign from All Traffic Solutions. The cost was \$4865.00, which was purchased with seized funds.

Attached is an invoice for your review.



A sign of the future.

A division of Intuitive Control Systems, LLC
 3100 Research Drive, State College, PA 16801
 Phone: 814-237-9005 Fax: 814-237-9006
 Tax ID: 25-1887906
 DUNS: 001225114

Invoice No.
 SIN006181

Invoice Date
 12/23/2014

Order No.
 SO-006504

Customer Purchase Order
 John Cooper

Bill To:
 City of Darien
 1710 Plainfield Road
 Darien, IL 60561
 John Cooper

Ship To:
 City of Darien
 John Cooper
 1710 Plainfield Road
 Darien, IL 60561

Payment Terms

Shipping Instructions

Ship Via

Net 30
 Item No.

None
 Description

Qty Ord	FedEx		Unit Price	Ext Price
	Qty Ship	Qty Back		

4000561	Shield 12 Speed Display; base unit w/ mounting bracket 12995014028330	1.0	1.0	\$3,150.00	\$3,150.00
4000647	App, Traffic Suite (12mo); Equip Mgmt, Reporting, Image Mgmt, Alerts, Mapping and PremierCare	1.0	1.0	\$1,500.00	\$1,500.00
4000767	Base Model CREDIT, speed display; requires min 1 yr TrafficCloud Traffic Suite	1.0	1.0	(\$800.00)	(\$800.00)
4000760	All Options Activation: Bluetooth, Traffic Data, Violator Alert, Pictures, Linking (as applic)	1.0	1.0	\$3,000.00	\$3,000.00
4000719	Options CREDIT; requires TrafficCloud Traffic Suite	1.0	1.0	(\$3,000.00)	(\$3,000.00)
4000613	LFP Power kit, 10Ah battery, internal power controller, charger with connector	1.0	1.0	\$400.00	\$400.00
4000639	LFP Battery, 10Ah LFP 12.8VDC (requires LFP Power Kit 4000613)	2.0	2.0	\$250.00	\$500.00
4000521	Mount Kit, (Sh12,Sh15,S18,iA18) addt'l mounting bracket, includes: bracket & hardware for pole	1.0	1.0	\$65.00	\$65.00
4000829	GSM H5 3G communications prep	1.0	1.0	\$0.00	\$0.00

Sale Amount	\$4,815.00
Shipping	\$50.00
Sales Tax	\$0.00
Balance DUE:	\$4,865.00

**Remit payment to the address listed above.
 A Finance Charge of 1.5% per month will be
 applied to overdue balances.**

CITY OF DARIEN

Police Department

12th POLICE PERIOD REPORT

December 2014

November 17, 2014 thru December 14, 2014

Professionalism

Integrity

Respect

Compassion

Inside This Issue

Department Highlights	2
Citizen Alerts	3-4
Community Engagement	5-6
Statistics	7-10

CANINE

One of the premier events for the Canine Team during this period was a collaborative effort with the Hinsdale South and Central schools where our canine team along with several other teams conducted random drug searches at the high school. There were no arrests in Darien (HSHS) but needless to say, high school administrators were pleased with the collaborative effort and outcomes. Our own Sergeant Steve Liss was appointed to head up the Canine Unit for FIAT. This is a great honor and Steve brings to the position a wealth of police expertise and vast experience as a canine handler and supervisor. We are proud of his appointment.

POLICE PERSONNEL

After exhaustive search process and numerous interviews the Darien Police Department hired a new Executive Assistant. Rosemary Gonzalez joined the Darien Police Department in December and will be assuming the role that has been held by Carol Kopta. Carol has decided to go into retirement to join her husband Tony in caring for their grandchildren, camping and traveling. We wish both Carol and Tony smooth sailing and a rich rewarding retirement. We thank Tony for sharing Carol with us for these many years.

DARIEN POLICE DEPARTMENT

During the FYE 2015 budget process, the police department requested and was granted funds to remodel the outdated Evidence and Property room. The retention of evidence is a core function of a police department and the integrity of that evidence must be above reproach. Prior to the remodel, we were using an outdated paper system of documenting evidence and a room with makeshift shelving units that was overflowing due to an inability to recognize the items that were no longer essential to prosecution. The new room will involve a new shelving system, bar coding and scanning of evidence. This brings our system into one that is more contemporary, in line with the other agencies in DuPage County and greatly enhances our ability to track our evidence and increase the integrity of the room. The project is slated for completion in mid-January.

Police Officer Kara Foyle-Price was returned to the Darien Police Department Detective Unit this month. Kara has previously worked in the Detective Unit, but was returned to patrol during an early reorganization. At that time, she was advised that she would be returning to detectives. Detectives, by policy, are intended to only serve for a finite period (5 years) in the unit. One of our detectives has been there considerably longer, and it is now time for Detective Foster to rotate out of detectives and return to patrol. Bill Foster came to the Darien Police Department from the Cicero, Illinois Police Department. Bill has served well in the Detective unit, carrying a full case load and handling very complex cases, including participating in the Kramer homicide in 2010. He will be missed in the detective unit and we wish him continued success as he returns to patrol duties. He will initially be detailed to the evidence room to aid in the remodeling project based upon his subject matter expertise in the area.

Our most recently hired police candidate, Eric Sarat, completed Suburban Law Enforcement Academy classes and graduated on December 19, 2014. Unfortunately, during the final weeks of his training, he was injured during a training exercise and will need to undergo surgery, requiring that his training be suspended. We wish him a speedy recovery and a timely return to the ranks to complete his field training.

NEW EQUIPMENT

As part of the Darien Police Department's on-going commitment to service and the acquisition of equipment that will further modernize the department and aid in serving our citizens, the Department has recently acquired a digital traffic sign that measures the speed of on-coming vehicles. This device is portable and is the first of two machines to be purchased. It not only provides immediate feedback to motorists, but also collects data for traffic surveys. This item was also purchased using monies seized and awarded to Darien through the efforts of our Task Force officer.

CITIZEN ALERTS

We have not experienced a residential burglary incident in Darien since November 17, 2014. It is my belief that the absence of burglaries is directly attributable to the collaboration between Darien residents and the Darien Police Department. For example, during our Town Hall Meeting we agreed that increased vigilance on the part of all concerned was critical in minimizing opportunities for burglars to commit crimes. During the 12th police period, we were able to note an increase in the number of suspicious activity calls by 156%. Numerically, that translates into 114 more calls than in the prior month. Our collective vigilance will continue to pay dividends, lower our burglary rate and make Darien an undesirable place to commit burglaries. In addition, we have enhanced communication related to home safety, increased the number of houses being watched in the house watch program. We increased house watch by 1,000% which represented a numerical increase of 151 more checks in the 12th period than in the prior police period. We engaged in increased patrols, added surveillance and other tactical and logistical strategies. The numeric increases in certain areas of activity are impressive, but the real measure of success is ZERO burglaries since the day in November when we had four on the same day. A more telling metric for success would be to continue the trend of ZERO throughout 2015 - Together We Can!

We recently published an alert regarding the possible use of GPS tracking devices being used by burglars in other jurisdictions across the country. These devices are easily and legally purchased from an array of vendors over the internet and at many security or spy stores. These devices can be surreptitiously placed on an unsuspecting victim's vehicle and the movement of that vehicle tracked using a lap top or desk top computer. We cannot say for certain that our recent burglaries were accomplished through this manner, but it is certainly worth arming ourselves against such efforts by burglars. To combat this you can check your vehicle by looking underneath your vehicle or in the wheel wells of the car which are the most likely places a burglar would secret the device. It is illegal in Illinois to place a tracking device on a vehicle without a court order, even for the police.

The Darien Police are continuing to receive reports from residents that were either a victim of a phone scam or an attempted scam. In the past two months, there have been 18 police reports; several of the scams caused significant monetary losses. We are providing our residents with a review of the reported incidents in the hopes that no one becomes a victim.

1. **Relative or Grandchild in Jail** - typically a call is targeted to older residents whereby the caller pretends to be a family member who has been arrested and needs bond money. The caller is relying on the resident to be hard of hearing or has not been in contact with the family in some time. Excuses are made by the caller that he has a cold to explain the change in voice, or a desperate need to get out of jail and to not notify parents. The caller instructs the resident to either wire money or purchase Green Dot gift cards. The caller will then obtain the PIN number on the gift card and wire money off of the card. The wire transfers are untraceable. **Do not act on the caller's instructions before actually talking to a family member to verify claim. Report incident to the police.**
2. **Internal Revenue Service -Warrant for Arrest** - residents continue to receive calls from individuals claiming to be from the IRS, that back taxes are owed, and threatens arrest unless payment is made. The callers have Middle-Eastern accents, yell and threaten the residents. In several cases, the resident's caller ID showed "IRS". A computer device can be purchased to display any phone number or name regardless of the originating call location. The IRS does not call and threaten residents with arrest on back tax cases. **This is a scam, hang up the phone and report incident to police.**

3. **Microsoft Monitoring Computer Issue or Virus** - residents are still receiving calls from individuals identifying themselves as a Microsoft employee that are monitoring a computer issue or virus on a resident's computer. The caller instructs the resident to allow remote access to their computer. Once the caller has access to your computer, they can download your computer hard drive files, passwords, bank account information, or add a virus or keystroke registry that will send the caller a detailed report of your computer activity including websites, user/password information. **Microsoft does not monitor anyone's computer, this is a scam. Hang up on caller and report incident to police.**
4. **Police Threaten Arrest** - a resident receives a voicemail from person claiming to be the police and threaten lawsuit unless resident returns call. **Legitimate police will not threaten lawsuit. Do not return phone call. Notify police.**
5. **Resident Receives Check** - Several residents have received inquiries on items they had for sale on CraigsList or other social media. The buyer sends a check in an amount larger than the agreed upon amount and then contacts seller to deposit check and return the overage. The checks are counterfeit. The buyer had no intention of making the purchase, only to have the resident cash a fake check and send money. If the resident cashes the check, the bank will require the resident to pay back the full amount. **If you receive a check and it is not the actual amount agreed to, do not cash. Contact your local bank and inquire as to whether the check is legitimate. Notify the police.**
6. **Resident Receives E-mail Asking for Copy of Passport** - a resident receives e-mail from individual claiming to be with a governmental agency in England that has the resident's luggage and needs a copy of their Passport. The e-mail originated in India. The resident has not traveled to England. The person is looking for personal identifiers that can be used for identity theft. **Do not respond to any inquiries that ask for your personal information.**
7. **Resident Responds to CraigsList for Equipment** - a resident responded to an ad on CraigsList for a piece of construction equipment for sale. The seller asked the resident to purchase Reloadit gift cards and then wired the money off of the gift cards. The wire transfer is untraceable. There was never an intent to sell this equipment, the ad was removed and immediately relisted for another victim. **Do not purchase any gift cards (GreenDot, Reloadit, or other cards) and then give out the PIN number.**
8. **ComED calls** - a resident received a call from an individual claiming to be from ComED, asking who handles bills in the home. The resident asked where the caller was calling from and the caller hung up. These calls are designed to have the resident give out their name, address and account number. The caller will then transfer other billing addresses onto the residents account. **Do not give out any personal information to any unsolicited caller.**
9. **Sweepstakes Scam** - resident receives call from individual claiming to be with Consumer Detection Bureau advising resident they won a second chance sweepstakes. Resident was instructed to purchase a Cashier's Check and send check. **Do not respond to calls that you are a "big winner".**

Please exercise caution when corresponding to unsolicited phone calls or e-mails. Do not give out any personal information and do not purchase gift cards for these callers. Hang up the phone and report incident to the police.

COMMUNITY ENGAGEMENT

Shortly after joining the Darien Police Department, I began participating in a mentoring group known as DAAWN. DAAWN is a tutoring and mentoring program that served students largely from LACE school and initially met in an apartment in the PONDS apartment complex in Westmont. The group now hosts its weekly meetings at St. John Lutheran Church at 7214 Cass in Darien. Last year the parent group for A.A.L.R. which stands for Asserting Achievement Literacy and Resiliency asked me to sit on their Board of Directors and I accepted the position and now serve on the Board as well as a committee. Their website is www.aalr4success.org. A.A.L.R is a non-profit, 501(c)-(3) comprised entirely of DuPage residents and professionals who volunteer their time. We are always looking for volunteers and tutors.

- On December 13, the A.A.L.R. held their annual holiday event and the Darien Police Department purchased a table consisting of a table of ten for the event. The event was hosted at Ashton Place and the group had a full house.
- Also on December 13, 2014 The Darien Police Department and DAR-WOOD fire service once again hosted the annual Shop with A Hero event. This event is supported and co-sponsored by the local Wal-Mart and allows almost 30 local children to select gifts for Christmas from throughout the store. One of the most heartwarming features of this event is to witness the really positive spirits of the children. When given the opportunity to get gifts for themselves they always choose to purchase gifts for their siblings or parents. The participants are selected by their schools and chosen to participate. This year, I had occasion to shop with Scotland Williams and her mother Mary and learned that Scotland, an 8th grade student with straight A's, wants to be a medical doctor. I also learned that she is in need of service points for school and she was offered and accepted the opportunity to earn her service points at the Darien Police Department this spring. In total, about one third of the Darien Police Department participated, shopped and wrapped gifts with the children.
- On Saturday December 20, 2014, I participated in the annual Lions Club holiday basket giveaway. This very worthwhile project also identifies the needs of specific families and donates gifts and foods sufficient to last for about two weeks, again to local families. It is truly a case of understanding what the season really means.

Beginning in 2015, we will begin recertifying members of the Darien Police Department on the proper installation of Child safety seats in automobiles. We were able to secure one seat in the upcoming class and we will follow that with two seats in the May 2015 class. In the interest of ensuring that Community Engagement is woven into the total fiber of the Darien Police Department, the training will be dispersed among Auxiliary, sworn officers and CSO personnel.

COMMUNITY ENGAGEMENT

12th Period 2014

November 17, 2014 thru December 14, 2014

VEHICLE BURGLARY PREVENTION HANG ONS - ELDERLY SERVICES - TOURS OF PD - TALKS WITH YOUTH GROUPS - ETC.

Number of Engagement Locations	34
Contact Time In Minutes	1911:01

LOCATION	1100 Hinswood	1222 Chapman	133 Plainfield	1410 75th	1500 Canterbury	1500 Pinehurst	1710 Plainfield	2101 75th	2220 Dunmore	2189 75th
TIME IN MINUTES	11:18	42:67	31:15	26:35	124:48	36:03	237:6	12:8	10:03	55:1

LOCATION	2301 Oakmont Wy	6600 Cass	6801 Wilmette	709 Plainfield	7112 High	7335 Cass	7414 Cass	7511 Lemont	7516 Cass	7550 Lyman
TIME IN MINUTES	6:77	72:63	0:3	72	59:22	2:53	26:78	48:02	30:24	210:87

LOCATION	8303 Sweet Water	8320 High Point	8517 Creekside	8700 Carriage Grn	8822 Carlisle	Carlisle / Kentwood	8832 Lake Ridge	8900 Tara Hill	Bailey / Willow Creek	Brandon / Middleton
TIME IN MINUTES	65:64	20:6	10:63	264:23	39:05	6:1	6:62	45:05	49:5	15:22

LOCATION	Carlisle / Frontage	Carlow / Branodn	Chapman / Bailey	Evergreen LN / CT
TIME IN MINUTES	36:78	37:2	149	7:05

<u>Schools Visits</u>		Cass	Concord	Eisenhower	Eliz-Ida	Lace	Lakeview	Mark Delay	OLOP
Number of Visits	TOTAL 3	1							1
Total Time In Minutes	TOTAL 171.75	9.1							42.92
		Kingswood	Prairieview						
		1							
		119.73							

STATISTICS

12TH PERIOD

November 17, 2014 thru December 14, 2014

Offense and Incident Report Statistics

Type	12th 2014	12th 2013	12th 2012	Percent Change	YTD 2014	YTD 2013	YTD 2012	Percent Change
Assault	0	0	1	NC	5	3	8	+66.6%
Burglary	0	4	6	-100%	15	29	37	-48.3%
Res Burglary	4	2	5	+100%	26	30	27	-13.3%
Criminal Damage	3	15	6	-80%	53	64	153	-17.2%
Criminal Trespass	3	0	1	+100%	7	5	8	-40%
Disorderly Conduct	2	4	8	-50%	56	54	50	+3.7%
Domestic Violence	12	9	16	+33.3%	162	137	132	+18.2%
Drug Offense	4	4	3	NC	30	37	46	-18.9%
Theft	18	23	8	-21.7%	164	129	115	+27.1%
Robbery	0	2	0	-100%	4	3	3	+33.3%
BMV	5	5	3	NC	48	40	77	+20%
CSA	0	0	0	NC	2	5	2	-60%
Battery	1	2	3	-50%	42	30	29	+40%
DUI	4	1	3	+300%	30	48	73	-37.5%
TOTAL	56	71	63	-16.4%	644	614	760	+4.9%

KEY STATISTICS

12th Period 2014

November 17, 2014 thru December 14, 2014

Type	12th 2014	12th 2013	12th 2012	Percent change	YTD 2014	YTD 2013	YTD 2012	Percent Change
Events Created	3268	1808	1405	+80.8%	27171	17249	21171	+57.5%
911 Calls	564	521	474	+8.2%	6337	6139	6526	+3.2%
Domestic Calls	20	23	66	-13%	245	248	327	-1.2%
Loud party	1	1	1	NC	26	30	35	-13.3%
Adult Arrest	39	50	60	-22%	600	590	927	+1.7%
Juvenile Arrest	10	14	13	-28.6%	81	109	113	-25.7%
Business checks	291	110	179	+164.5%	1602	1209	2767	+32.5%
Lock out	14	29	31	-51.7%	243	300	312	-19%
House Checks	166	15	17	1006.7%	264	215	375	+22.8%
Assist Other Agency	24	32	36	-25%	369	352	312	+4.8%
Motorist Assists	24	28	13	-14.3%	289	242	249	+19.4%
Suspicious Activity	187	73	66	+156.2%	793	698	843	+13.6%
School Visitation	4	63	0	-93.7%	345	66	0	+422.7%
School Presentation	1	2	0	-50%	21	2	0	+950%
Park Duties	0	0	0	NC	225	176	0	+27.8%
Community Engagement	48	5	0	+860%	486	169	0	+187.6%
Warrants	6	6	6	NC	44	56	125	-21.4%

ARREST STATISTICS

12th Period 2014

November 17, 2014 thru December 14, 2014

	12th 2014	12th 2013	12th 2012	Percent change 2014- 2013	YTD 2014	YTD 2013	YTD 2012	Percent Change 2014- 2013
Number of Arrests:	49	64	73	-23.4%	681	699	1040	-2.6%
	Charges Filed:							
Battery	0	1	1	-100%	11	9	4	+22.2%
Domestic Battery	1	2	1	-50%	22	22	30	NC
Theft	1	1	3	NC	4	7	14	-42.9%
Retail Theft	8	6	4	+33.3%	86	21	44	+309.5%
Drug Offenses	1	3	1	-66.7%	32	28	37	+14.3%
Illegal Possession of Alcohol/Minor	0	4	1	-100%	1	6	2	-83.3%
Illegal Consumption of Alcohol/Minor	1	4	4	-75%	8	15	20	-46.6%
DUI	4	1	3	+300%	29	46	71	-37%
Illegal Transportation of Liquor	1	0	1	+100%	10	7	14	+42.9%
Disorderly Conduct	2	0	0	+100%	4	15	5	-73.3%
TOTAL	19	22	19	-13.6%	207	176	241	+17.6%

Actual 911 Calls by Shift

Shift	Dispatched	Time	Conversion to Hours	% of Total 911	% of Total Time
Day Shift	269	13501.74	225	47.7%	43.1%
Afternoon	230	11669.56	194.5	40.8%	37.3%
Midnights	65	6151.27	102.5	11.5%	19.6%
Mini-Mids *	19	3818.48	63.6	3.4%	12.2%
Totals	564	31322.57	522	100%	100%

OFFICER STATISTIC

12th Period 2014

November 17, 2014 thru December 14, 2014

<i>Officer Statistics</i>							
<i>Officer</i>	<i>Patrol Shifts Worked</i>	<i>Citations</i>	<i>Traffic Warnings</i>	<i>Self-Initiated</i>	<i>Traffic</i>	<i>911 Calls</i>	<i>Average 911 Per Day</i>
<i>First Shift - Mids</i>							
<i>Sgt. Piccoli</i>	18	0	0	10	0	0	0
<i>Sgt. Greenaberg</i>	20	3	2	28	8	7	0.35
<i>Ofc. Kosieniak</i>	20	1	4	142	5	12	0.60
<i>Ofc. Hruby</i>	14	6	11	62	30	9	0.64
<i>Ofc. Keough</i>	14	6	24	161	22	9	0.64
<i>Ofc. Camacho</i>	19	14	11	267	23	12	0.63
<i>Ofc. Pastick</i>	20	13	21	272	28	32	1.60
<i>Total</i>	125	43	73	942	116	81	2.90
<i>Second Shift - Days</i>							
<i>Sgt. Topel</i>	15	0	0	27	0	14	0.93
<i>Ofc. Murphy</i>	17	0	0	56	0	25	1.47
<i>Ofc. Hellmann</i>	19	3	0	110	0	41	2.15
<i>Ofc. Lorek</i>	17	11	1	63	9	18	1.05
<i>Ofc. Renner</i>	14	1	6	87	9	31	2.21
<i>Ofc. Jump</i>	19	8	4	99	12	39	2.05
<i>Ofc. Dollins</i>	20	8	5	243	11	54	2.70
<i>Total</i>	121	31	16	685	41	222	7.90
<i>Third Shift - Afternoons</i>							
<i>Sgt. Rentka</i>	19	0	0	11	0	4	0.21
<i>Sgt. Liss</i>	19	2	1	38	4	6	0.32
<i>Ofc. Liska - PS</i>	11.5	1	2	41	2	9	0.78
<i>Ofc. Bischoff - PS</i>	18	2	7	102	6	16	0.89
<i>Ofc. Foyle-Price</i>	16.5	2	5	79	5	23	1.39
<i>Ofc. Yeo</i>	15	1	5	61	5	31	2.07
<i>Ofc. Skweres</i>	20	8	7	155	14	34	1.70
<i>Ofc. Simek</i>	9	2	5	61	6	7	0.70
<i>Ofc. Zimny</i>	19.50	3	9	242	10	44	2.26
<i>Ofc. Rumick</i>	18	3	13	209	12	39	2.17
<i>Ofc. Milazzo</i>	19.5	8	3	78	8	48	2.46
<i>Total</i>	185	32	57	1077	72	261	9.30